



saune | saunas



bagni turchi | steam baths



effetti d'acqua | *water experience*



relax | *relaxation*

 **Stenal**  
wellness industries





fatto a mano, con il cuore, in Italia

*hand made, with love, in Italy*

Tecnologie e attrezzature per il benessere realizzate su misura, secondo le esigenze del singolo Cliente.

La qualità secondo Stenal: eccellenza del made in Italy ed esperienza dei maestri artigiani che vi lavorano da sempre.

Nel nostro DNA: la tradizione millenaria di benessere e termalismo del parco nazionale dei Colli Euganei.

*Bespoke wellness technology and equipment designed to meet the needs of each unique Customer.*

*Quality according to Stenal: the excellence of products Made in Italy and the lifelong experience of dedicated craftsmen.*

*Our DNA: the century-long wellness and thermal tradition of Colli Euganei national park.*





Dal 1980, due generazioni, una storia di famiglia.

*Since 1980, two generations, a family story.*

## La nostra storia

### 1980

Fondazione, nel cuore del distretto termale Abano - Montegrotto.

### 1985

Acquisizione del primo impianto produttivo per saune onde poter dare vita con creatività e cura del dettaglio ai progetti specifici di clienti e designers.

### 1990

Fondazione del reparto elettromeccanico per la produzione delle tecnologie per bagno turco.

### 2001

Il nuovo secolo comincia con nuove sfide. L'attività si espande anche fuori dall'Europa.

### 2006

Nuovo stabilimento produttivo ed espositivo di 2500 m<sup>2</sup>.

### 2007

Si conclude il passaggio generazionale e si aprono nuove prospettive per il futuro, con importanti investimenti in ricerca e sviluppo.

### 2008

Viene fondata la divisione Contract civile, per dare la necessaria consulenza progettuale e supporto produttivo ai nostri partner.

### 2012

Viene fondata la divisione Contract navale, frutto dell'esperienza e delle competenze acquisite nel corso degli anni riguardo le tecniche e le normative di costruzione a bordo.

### 2015

Aperti uffici in Asia e America centrale

### 2016

Creazione network capillare di centri assistenza su tutto il territorio italiano e nei principali mercati esteri.

### 2020

40 anni di attività, una squadra di 35 persone, 36 anni età media dello staff, 15 anni l'anzianità media lavorativa in azienda, installazioni in 5 continenti e 48 paesi.

Ascoltiamo con grande attenzione i nostri clienti, e li affianchiamo con successo nell'analisi delle esigenze progettuali al fine di proporre soluzioni sempre mirate e personali.

Impegno, passione, determinazione. Orgoglio per un lavoro ben fatto.

Questi siamo noi.

## Our story

*Founded, in the heart of the thermal area of Abano-Montegrotto.*

*Stenal acquires its first sauna production plant, bringing to life the projects of customers and designers with creativity and the utmost attention to details.*

*The electro-mechanical department is founded to develop steam bath technology.*

*The new century starts with new challenges. The business expands also outside Europe.*

*New 2500 m<sup>2</sup> production plant and showroom.*

*The new generation brings an innovative approach, with important research and development investments.*

*The Civil Contract division is founded to offer planning assistance and production to support to our partners.*

*The Naval Contract division is founded thanks to the skills and experience in on-board construction techniques and regulations acquired during the years.*

*Opened offices in Asia and Central America*

*Creation of a broad network of technical assistance centres in Italy and in our main markets abroad.*

*40 years of activity; a team of 35 people, with an average age of 36 and an average career length of 15 years; works carried out across 5 continents and 48 different countries.*

*We listen carefully to our customers and successfully support them during the planning stages in order to offer bespoke solutions based on their individual needs.*

*Committed, passionate, determined. Proud of doing a good job.*

*This is us.*

Amore per l'ambiente, per un futuro sostenibile.

*Love for the environment, for a sustainable future.*



Le nostre saune sono costruite nel rispetto dell'ambiente: adottiamo materiali e sistemi produttivi che non creano squilibri ambientali.

Le nostre cabine sono dotate di elevato isolamento termico per ridurre il consumo energetico, e le nostre tecnologie per docce emozionali utilizzano controlli intelligenti e ugelli speciali per ottimizzare il consumo di acqua.

I legnami utilizzati provengono da piantagioni ecologiche certificate, e le nostre creazioni vengono realizzate interamente nei nostri stabilimenti, rispettando in ogni passaggio l'etica del lavoro artigianale e della qualità premium dell'autentico prodotto italiano.

*Our saunas are made with respect for the environment: the materials and production methods we use do not create ecological imbalance.*

*Our thermal cabins are designed to reduce energy loss, and our experience shower systems use smart controls and special nozzles to reduce water consumption.*

*Our timber comes from certified ecological plantations and our products are entirely manufactured in our production plants, following the ethical principals. Hand crafting in all production stages, offering the superior quality of authentic Italian products with minimal waste.*



Ogni spa è unica. Forniamo servizi di consulenza specializzata per supportare i nostri clienti nelle decisioni strategiche, design e tender.

*Every spa is unique. We provide experienced and specialised consultancy services to support our client's strategic choices, design, and tender.*

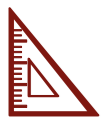

Progettiamo, costruiamo e installiamo le funzioni della Spa con grande attenzione alla prefabbricazione e all'affidabilità.

*We design, build and install the Spa features, with a strong focus on prefabrication and reliability.*



Le nostre formule di assistenza su misura e il pacchetto di estensione della garanzia assicurano la manutenzione costante della spa, per performance sempre al top.

*Our after sales programmes and the extended warranty packages ensure to our Clients the best maintenance and performance for their spa.*



Realizziamo i nostri prodotti in maniera quanto più possibile prefabbricata, così da ridurre la complessità dei cantieri; in questo modo rispettiamo costi e tempi di consegna.

*Stenal provides technologies and equipment as prefabricated as possible, in order to significantly reduce the installation time on site – and to ensure that the construction timelines and budget are respected.*

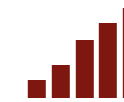

Quando la spa sarà operativa, il cliente apprezzerà la funzionalità di ogni singola attrezzatura: facilità d'uso, manutenzioni ridotte, risparmio energetico e alte prestazioni sono tutti vantaggi che derivano dalla corretta realizzazione.

*When the spa will start working, the Client will appreciate the functionality of each single cabin: easiness of use, reduced maintenance and high performances are all advantages resulting from proper construction.*

Alexa, accendi la sauna  
 Alexa, turn on the sauna

Ok Google, accendi il bagno turco  
 Ok Google, turn on the steam room

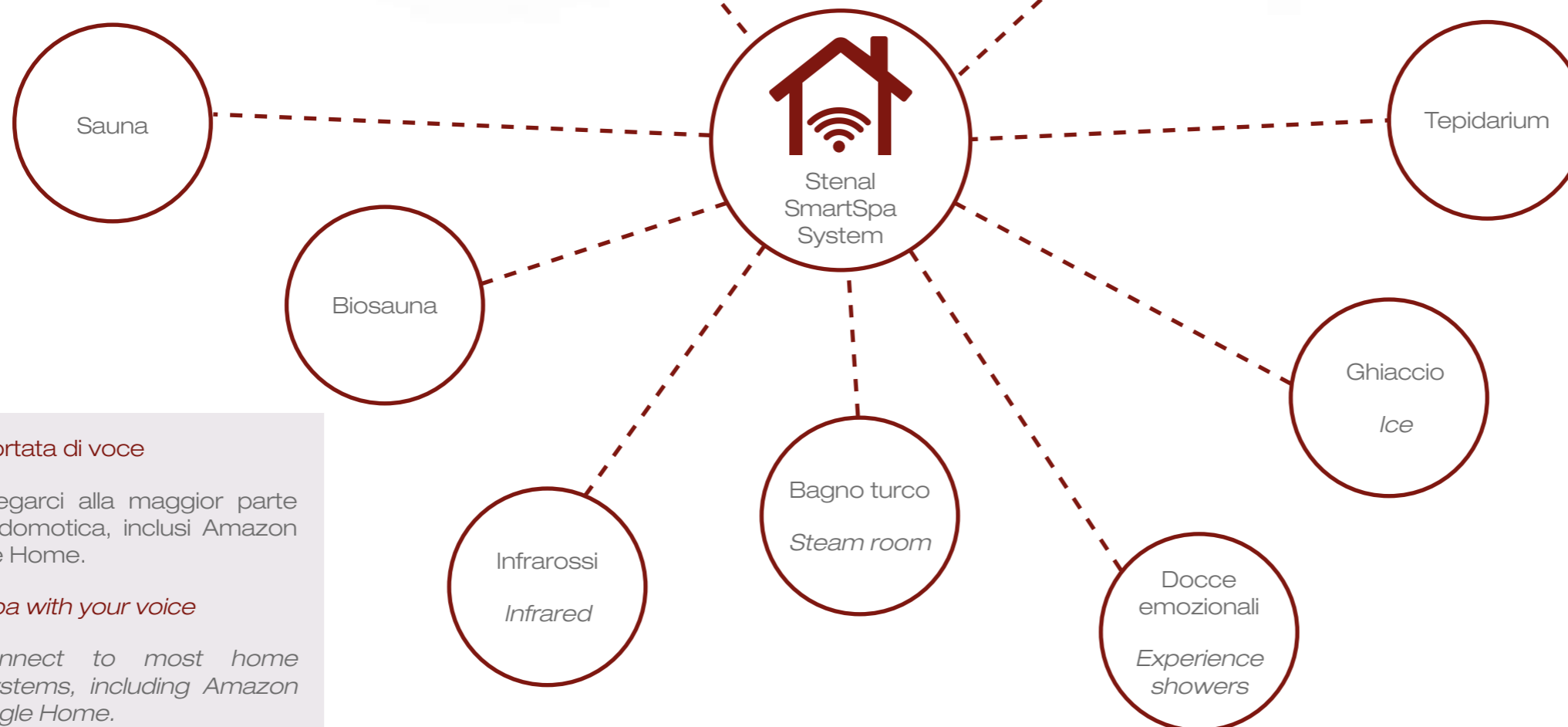

La tua spa a portata di voce

Possiamo collegarci alla maggior parte dei sistemi di domotica, inclusi Amazon Alexa e Google Home.

*Control your spa with your voice*

*We can connect to most home automation systems, including Amazon Alexa and Google Home.*



Compatibilità iOS /Android

Controlla la spa in mobilità con la nostra app

*iOS / Android compatibility*

*Control your spa on mobile with our app*

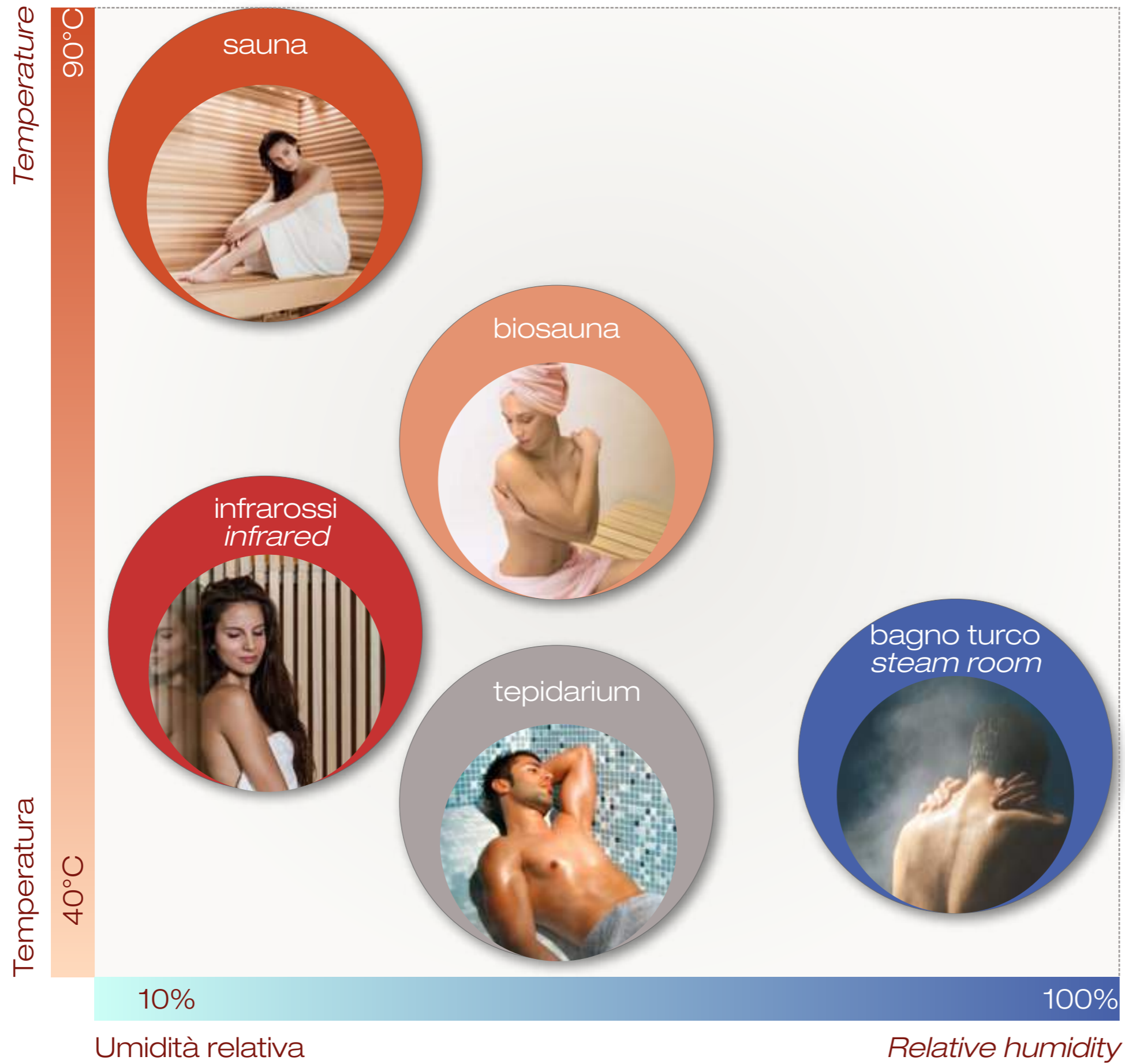

Ogni esperienza di benessere è unica e personale. I prodotti Stenal offrono una scelta di combinazioni perfette di temperatura e umidità.

*Every wellness experience is unique and personal. Stenal's products offer a range of perfect combinations for temperature and humidity.*





Scegliere Stenal significa scegliere un'esperienza di benessere costruita con la conoscenza e l'esperienza di due generazioni, e con l'orgoglio di realizzare un prodotto sempre su misura, sempre unico.

*When you choose Stenal, you choose a wellness experience built with the knowledge and experience of two generations, and the pride that comes with creating a unique, bespoke product every time.*

## Indice

## Table of contents

### il calore delle saune | *sauna heat experiences*

Elite .....	36
Evolution .....	48
Topclass.....	58
Elegant .....	68
Antique .....	78
Configurazioni   <i>configurations</i> .....	84
Optional.....	101
Infrarossi   <i>infrared</i> .....	104
Outdoor.....	110

### il tepore dei bagni turchi | *steam warmth experiences*

SteamCustom .....	118
Configurazioni   <i>configurations</i> .....	132
Optional .....	146
Moon .....	156
SteamShower .....	166

### la magia dell'acqua | *the magic of water*

Ray .....	176
Ray Plus.....	180
Chromo .....	184
Island.....	188
Paradise .....	192
Scozia .....	198
Doccia rustica   <i>Bucket shower</i> .....	202
Kneipp .....	204
Ghiaccio   <i>ice</i> .....	208
Polaris .....	212

### le soluzioni per il relax | *ideas for relaxation*

Alba .....	218
Alba Plus.....	222
Flex 4 .....	226
Tepidarium .....	230
Parete di sale   <i>Salt wall</i> .....	237
Tepidarium al sale   <i>Salt tepidarium</i> .....	241
myHeat .....	244
Stone Q .....	246
Foot spa .....	250
Disinfezione piedi   <i>Feet disinfection</i> .....	254

### le ispirazioni per il benessere | *spa design inspirations*

80 m <sup>2</sup> .....	258
100 m <sup>2</sup> .....	260
200 m <sup>2</sup> .....	262
450 m <sup>2</sup> .....	264



il calore delle saune  
*sauna heat experiences*

Sauna Evolution 70 m<sup>2</sup> con effetto Vulcano  
*Evolution sauna 70 m<sup>2</sup> with Volcano feature*



Sauna Topclass con parete di sale  
*Topclass sauna with backlit salt wall*

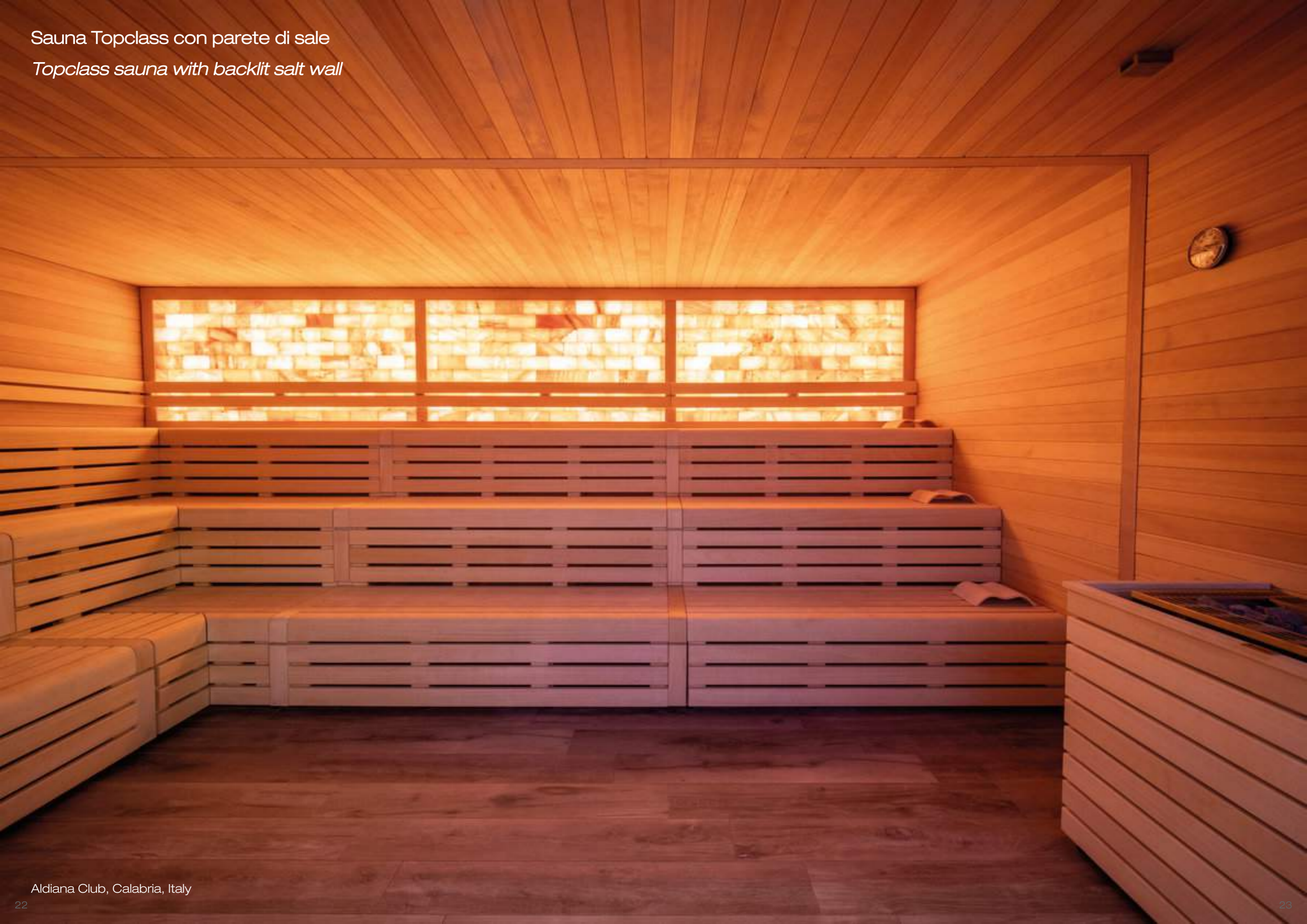

Sauna nella foresta

*Forest sauna*



Aqua Sana spa, Sherwood Forest, UK

Sauna Elite con biosauna  
*Elite sauna with biosauna*



Sauna Topclass con decorazione retroilluminata

*Topclass sauna with backlit decoration*



Sauna Evolution panoramica

*Panoramic Evolution sauna*



Hotel Tergesteo, Montegrotto Terme, Italy





Ottimale ricambio dell'aria

Un aspetto fondamentale per il corretto funzionamento di una sauna è il ricircolo dell'aria, che deve cambiare 6 volte ogni ora, al fine di garantire un ambiente sempre sano e piacevole.

Optimal air circulation

Air circulation is essential to the correct functioning of a sauna. Air must be replaced 6 times every hour, in order to guarantee a healthy and pleasant environment at all times.

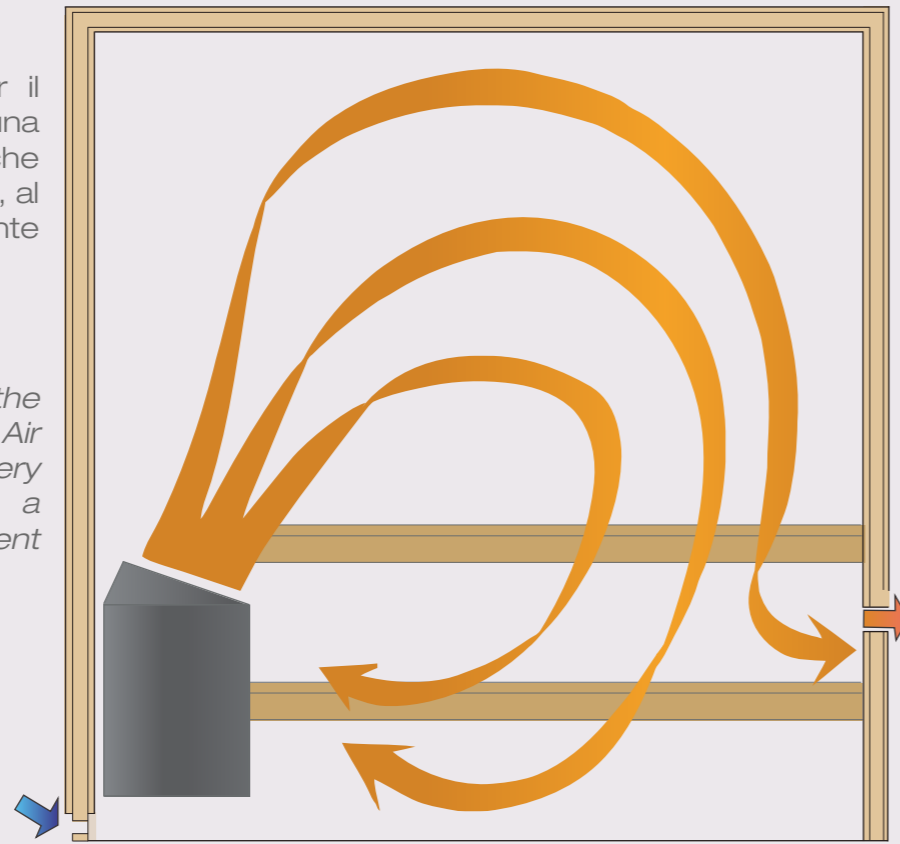

Flusso d'aria regolabile

La perfetta sessione di sauna è quella che puoi personalizzare. Per questo ogni sauna Stenal è dotata di un elegante regolatore che permette di variare il flusso dell'aria all'interno della cabina.

Adjustable air flow

The perfect sauna session is one that you can personalise. This is why all Stenal saunas have an elegant air flow control that allows adjustments to the air flow inside the cabin.

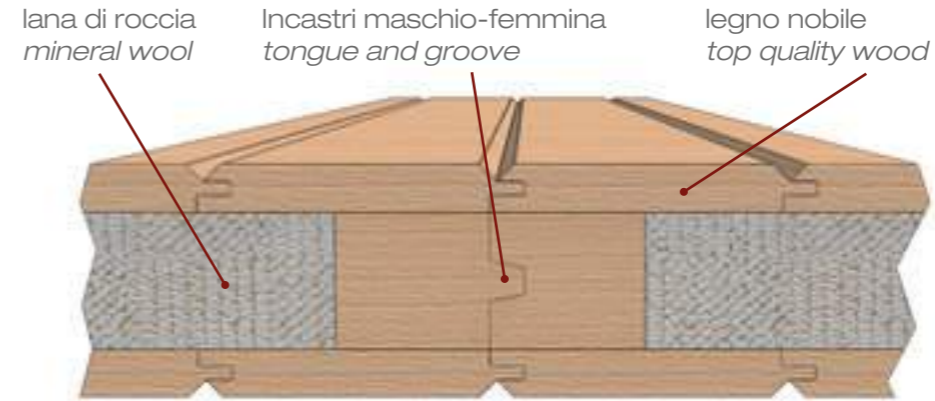

Pareti:

L'isolamento è realizzato in lana di roccia, che assicura un'ottima performance termoisolante ed è un prodotto eco-compatibile.

Walls:

Mineral wool is used as filling, because it provides perfect thermal insulation and is an eco-friendly material.

Esclusivo sistema Stenal QuickFix:

Stenal QuickFix è il sistema di montaggio veloce studiato appositamente per diminuire drasticamente i tempi e i costi di lavorazione in cantiere. Ogni singolo componente è già stato collaudato precedentemente in fabbrica e tutti i pezzi si incastrano in modo veloce ed univoco tra di loro per garantire un montaggio a regola d'arte.

Exclusive Stenal QuickFix System:

Stenal QuickFix is a system designed to significantly reduce the installation times and costs. Each component is tested in advance at our production plant so that all pieces can be assembled quickly and fit together perfectly.

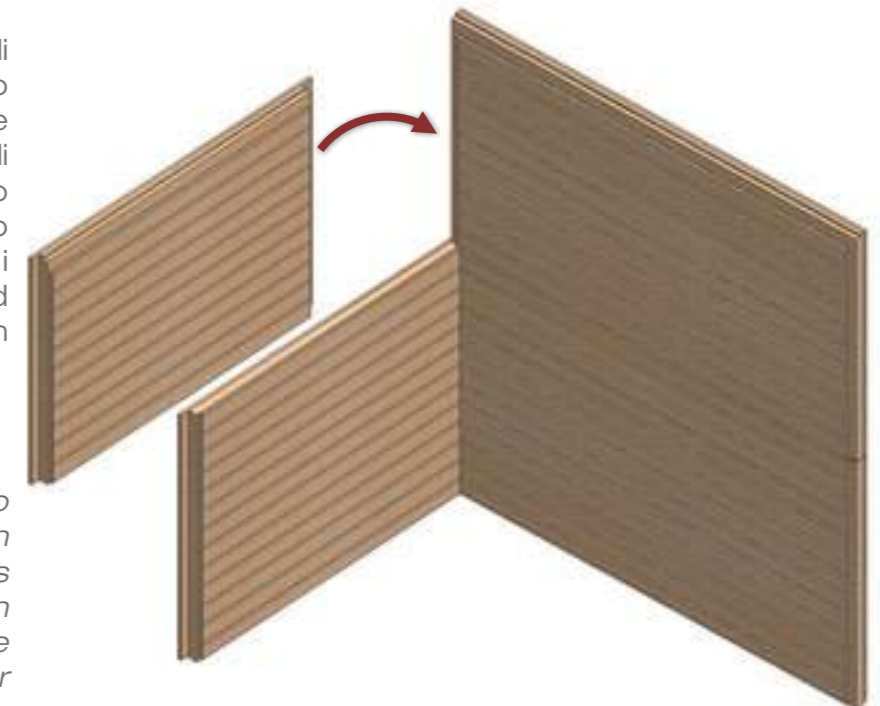

Spazio sotto panca facilmente accessibile:

Il sistema di apertura delle panche consente una facile ispezione e pulizia.

Easy access for cleaning below the bench:

The bench opening system allows for easy inspection and cleaning.

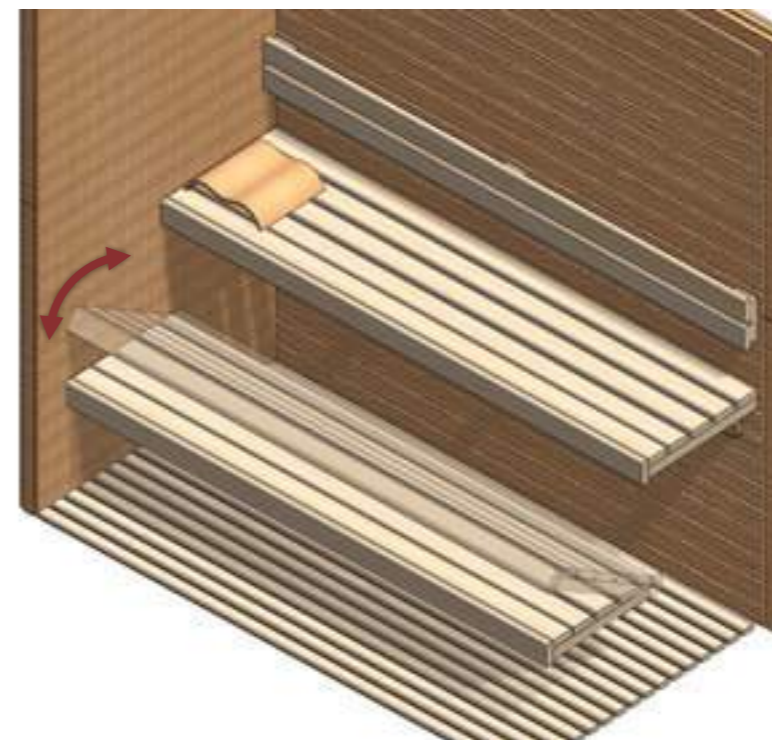

Elite  
corner



# Elite

incasso | *built-in*

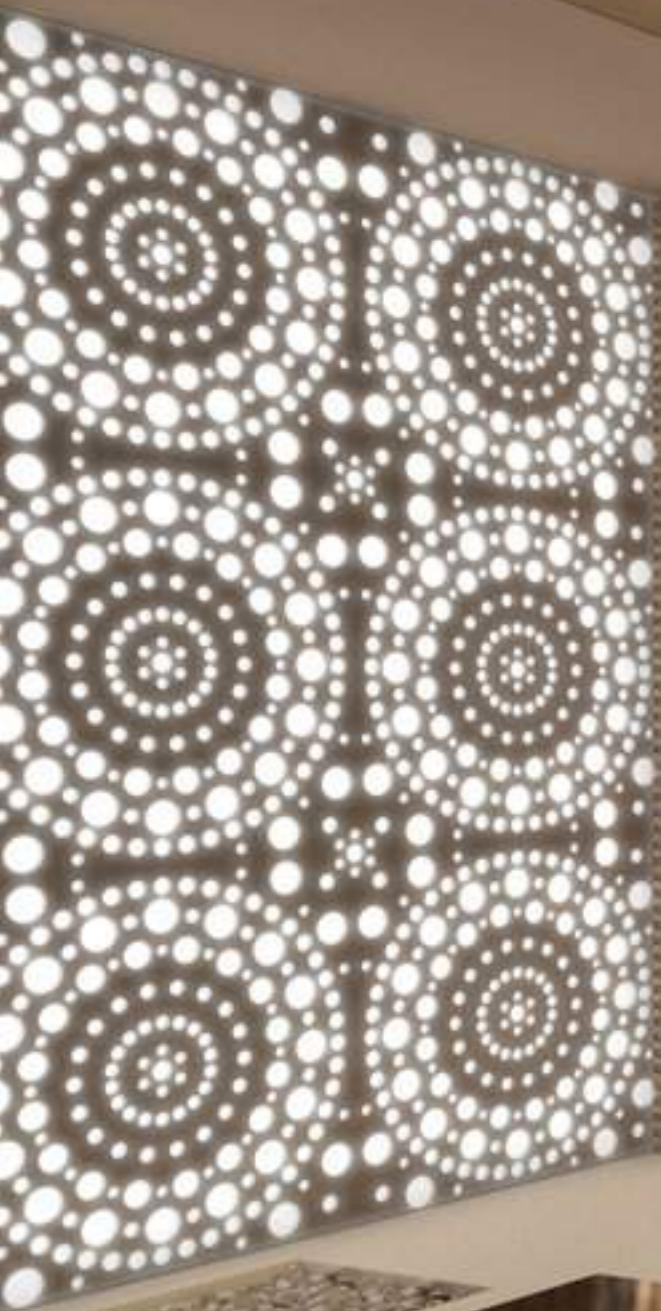



## Dettagli

## Details



**Maniglia** in legno e acciaio inox.  
**Cerniere** certificate per 30.000 aperture.  
**Stufa** rivestita in legno.  
**Giunzioni** invisibili senza viti a vista.

*Handle* made of wood and stainless steel.  
*Hinges* certified for 30,000 openings.  
*Heater* covered with wood.  
*Invisible joints* with no visible screws.





Pareti: Cedro a listelli

*Walls: milled Cedar*

scala 1:1

*scale 1:1*

Panche: Cedro a listelli

*Benches: Cedar strips*

scala 1:1

*scale 1:1*

## Scheda tecnica: sauna Elite

Funzioni	Sauna finlandese
Temperatura	60 – 90°C
Umidità relativa	10 – 15%
Sistema di riscaldamento	Stufa elettrica adatta per uso professionale continuativo
Sistema di controllo	Tastiera esterna remotabile
Tensione elettrica	Standard 400V trifase, su richiesta 230V monofase
Potenza elettrica	A seconda delle dimensioni
Materiale pareti	Legno di cedro rosso canadese naturale essiccato, un legno pregiato che presenta un profumo particolare e inconfondibile
Decoro pareti	Listelli orizzontali in rilievo. La particolare lavorazione aumenta la superficie di legno esposta all'aria, esaltandone il profumo
Spessore pareti	mm 77÷94
Profumo del legno	●●●●○
Pavimento	In legno, a griglia rigida, da installare in appoggio sul pavimento esistente
Porta	In cristallo temperato. Luce netta di passaggio cm 70x199. Spessore: 8mm
Forma delle panche	Sospese
Materiale delle panche	Cedro rosso canadese naturale essiccato
Illuminazione	Punti luce lungo il perimetro del soffitto
Colore della luce	Bianco caldo 2700°K
Prodotti di consumo	Inclusa essenza Stenal Classic 0,5l
A cura del cliente	Pavimento perfettamente orizzontale e planare, rivestito in materiale lavabile (consigliato: gres porcellanato), allacciamento elettrico in corrispondenza del quadro elettrico
Manutenzioni periodiche	Pulizia con un panno bagnato e poche gocce di Destacryl (consigliato)
Normativa	CE; su richiesta ETL per alcuni modelli
Produzione	Made in Italy

## Datasheet: sauna Elite

Features	Finnish sauna
Temperature	60 – 90°C
Humidity	10 – 15%
Heating system	Electric heater suitable for professional continuous usage
Control system	External controls
Voltage	Standard 400V 3-phase, optional 230V 1-phase
Power consumption	Depending on size
Walls material	Natural dried Canadian red cedar, top-quality wood with a unique and distinctive fragrance
Walls decoration	Horizontal strips in relief. A specific milling increases the wood surface exposed to the air, enhancing its fragrance
Walls thickness	mm 77÷94
Wood fragrance	●●●●○
Floor	Rigid wooden grille, to be positioned on the existing floor
Door	Tempered glass. Door clearance: 70x199 cm. Thickness: 8mm
Bench design	Suspended
Bench material	Natural dried Canadian red cedar
Lighting	Spots of light along the perimeter of the ceiling
Light colour	Warm white 2700°K
Included	Fragrance Stenal Classic 0,5l
Preparations by Others	Perfectly level floor, covered in washable material (we recommend ceramic tiles), power supply next to the electric panel
Regular maintenance	Clean using a wet cloth and a few drops of Destacryl (recommended)
Norms	CE, on request ETL on select models
Production	Made in Italy



# Evolution incasso | *built-in*



# Evolution corner





## Dettagli

## Details

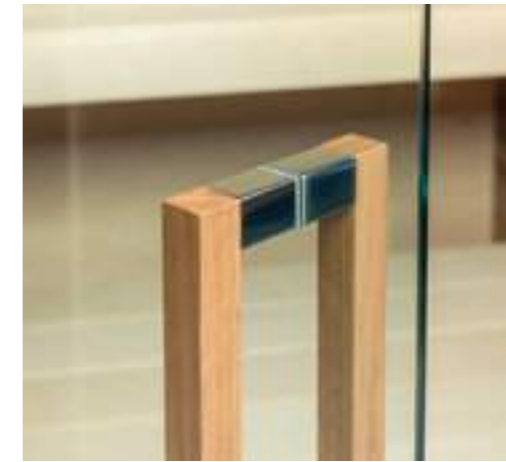

**Maniglia** in legno e acciaio inox.  
**Cerniere** certificate per 30.000 aperture.  
**Stufa** rivestita in legno.  
**Giunzioni** invisibili senza viti a vista.

*Handle* made of wood and stainless steel.  
*Hinges* certified for 30,000 openings.  
*Heater* covered with wood.  
*Invisible joints* with no visible screws.



Pareti: Frassino termotrattato

*Walls: thermo-treated Ash wood*

scala 1:1

*scale 1:1*

Panche: Tiglio naturale essiccato

*Benches: Natural dried Linden wood*

scala 1:1

*scale 1:1*

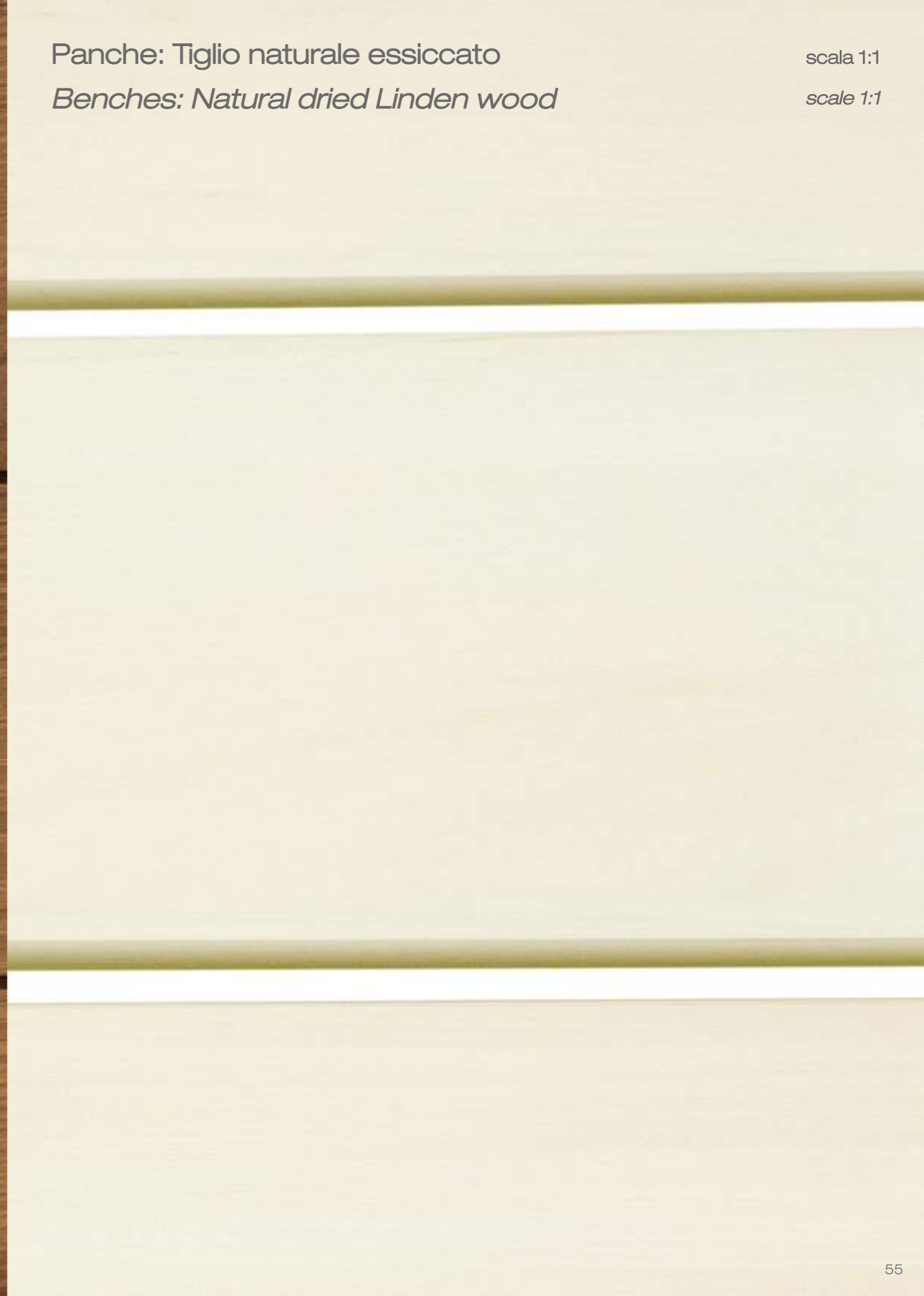

## Scheda tecnica: sauna Evolution

Funzioni	Sauna finlandese
Temperatura	60 – 90°C
Umidità relativa	10 – 15%
Sistema di riscaldamento	Stufa elettrica adatta per uso professionale continuativo
Sistema di controllo	Tastiera esterna remotabile
Tensione elettrica	Standard 400V trifase, su richiesta 230V monofase
Potenza elettrica	A seconda delle dimensioni
Materiale pareti	Legno di Frassino, termotrattato per ottenere il tipico colore brunito
Decoro pareti	Doghe orizzontali
Spessore pareti	mm 73÷86
Profumo del legno	●●●○○
Pavimento	In legno, a griglia rigida, da installare in appoggio sul pavimento esistente
Porta	In cristallo temperato. Luce netta di passaggio cm 70x199. Spessore: 8mm
Forma delle panche	Sospese
Materiale delle panche	Legno di Tiglio naturale essiccato, a doghe larghe
Illuminazione	Punti luce lungo il perimetro del soffitto
Colore della luce	Bianco caldo 2700°K
Prodotti di consumo	Inclusa essenza Stenal Classic 0,5l
A cura del cliente	Pavimento perfettamente orizzontale e planare, rivestito in materiale lavabile (consigliato: gres porcellanato), allacciamento elettrico in corrispondenza del quadro elettrico
Manutenzioni periodiche	Pulizia con un panno bagnato e poche gocce di Destacryl (consigliato)
Normativa	CE; su richiesta ETL per alcuni modelli
Produzione	Made in Italy

## Datasheet: sauna Evolution

Features	Finnish sauna
Temperature	60 – 90°C
Humidity	10 – 15%
Heating system	Electric heater suitable for professional continuous usage
Control system	External controls
Voltage	Standard 400V 3-phase, optional 230V 1-phase
Power consumption	Depending on size
Walls material	Ash wood, thermo-treated to obtain the traditional brownish colour
Walls decoration	Horizontal boards
Walls thickness	mm 73÷86
Wood fragrance	●●●○○
Floor	Rigid wooden grille, to be positioned on the existing floor
Door	Tempered glass. Door clearance: 70x199 cm. Thickness: 8mm
Bench design	Suspended
Bench material	Wide boards of natural dried linden
Lighting	Spots of light along the perimeter of the ceiling
Light colour	Warm white 2700°K
Included	Fragrance Stenal Classic 0,5l
Preparations by Others	Perfectly level floor, covered in washable material (we recommend ceramic tiles), power supply next to the electric panel
Regular maintenance	Clean using a wet cloth and a few drops of Destacryl (recommended)
Norms	CE, on request ETL on select models
Production	Made in Italy

# Topclass incasso | *built-in*



# Topclass corner





## Dettagli

## Details



Maniglia in legno e acciaio inox.  
Cerniere certificate per 30.000 aperture.  
Stufa rivestita in legno.  
Giunzioni invisibili senza viti a vista.



*Handle made of wood and stainless steel.  
Hinges certified for 30,000 openings.  
Heater covered with wood.  
Invisible joints with no visible screws.*





Pareti: Hemlock canadese

*Walls: Canadian Hemlock*

scala 1:1

*scale 1:1*

Panche: Ayous atermico

*Benches: Ayous athermic wood*

scala 1:1

*scale 1:1*



## Scheda tecnica: sauna Topclass

Funzioni	Sauna finlandese
Temperatura	60 – 90°C
Umidità relativa	10 – 15%
Sistema di riscaldamento	Stufa elettrica adatta per uso professionale continuativo
Sistema di controllo	Tastiera esterna remotabile
Tensione elettrica	Standard 400V trifase, su richiesta 230V monofase
Potenza elettrica	A seconda delle dimensioni
Materiale pareti	Legno Hemlock canadese naturale essiccato. Questo legno dal colore molto caldo non presenta nodi e garantisce una perfetta durata nel tempo
Decoro pareti	Doghe orizzontali
Spessore pareti	mm 68
Profumo del legno	●○○○○
Pavimento	In legno, a griglia rigida, da installare in appoggio sul pavimento esistente
Porta	In cristallo temperato. Luce netta di passaggio cm 70x199. Spessore: 8mm
Forma delle panche	Sospese
Materiale delle panche	Legno atermico Abachi a doghe larghe
Illuminazione	Led lineari dietro schienale e sotto panca
Colore della luce	Bianco caldo 2700°K
Prodotti di consumo	Inclusa essenza Stenal Classic 0,5l
A cura del cliente	Pavimento perfettamente orizzontale e planare, rivestito in materiale lavabile (consigliato: gres porcellanato), allacciamento elettrico in corrispondenza del quadro elettrico
Manutenzioni periodiche	Pulizia con un panno bagnato e poche gocce di Destacryl (consigliato)
Normativa	CE; su richiesta ETL per alcuni modelli
Produzione	Made in Italy

## Datasheet: sauna Topclass

Features	Finnish sauna
Temperature	60 – 90°C
Humidity	10 – 15%
Heating system	Electric heater suitable for professional continuous usage
Control system	External controls
Voltage	Standard 400V 3-phase, optional 230V 1-phase
Power consumption	Depending on size
Walls material	Natural dried Canadian Hemlock wood. This warm-coloured wood is extremely durable and has no knots
Walls decoration	Horizontal boards
Walls thickness	mm 68
Wood fragrance	●○○○○
Floor	Rigid wooden grille, to be positioned on the existing floor
Door	Tempered glass. Door clearance: 70x199 cm. Thickness: 8mm
Bench design	Suspended
Bench material	Wide boards of athermic Abachi wood
Lighting	Linear LED lights behind the backrest and below the bench
Light colour	Warm white 2700°K
Included	Fragrance Stenal Classic 0,5l
Preparations by Others	Perfectly level floor, covered in washable material (we recommend ceramic tiles), power supply next to the electric panel
Regular maintenance	Clean using a wet cloth and a few drops of Destacryl (recommended)
Norms	CE, on request ETL on select models
Production	Made in Italy

# Elegant corner



# Elegant incasso | *built-in*





## Dettagli

## Details



Maniglia in legno e acciaio inox.  
Cerniere certificate per 30.000 aperture.  
Stufa rivestita in legno.  
Giunzioni invisibili senza viti a vista.

*Handle made of wood and stainless steel.  
Hinges certified for 30,000 openings.  
Heater covered with wood.  
Invisible joints with no visible screws.*



Pareti: Abete di Svezia

*Walls: Swedish Fir*

scala 1:1

*scale 1:1*

Panche: Ayous atermico

*Benches: Ayous athermic wood*

scala 1:1

*scale 1:1*

## Scheda tecnica: sauna Elegant

Funzioni	Sauna finlandese
Temperatura	60 – 90°C
Umidità relativa	10 – 15%
Sistema di riscaldamento	Stufa elettrica adatta per uso professionale continuativo
Sistema di controllo	Tastiera esterna remotabile
Tensione elettrica	Standard 400V trifase, su richiesta 230V monofase
Potenza elettrica	A seconda delle dimensioni
Materiale pareti	Abete di Svezia naturale essiccato. Questo legno, usato in Nord Europa per costruire saune sin dall'antichità, conferisce alla sauna il caratteristico aspetto caldo e avvolgente
Decoro pareti	Doghe orizzontali
Spessore pareti	mm 68
Profumo del legno	●●○○○
Pavimento	In legno, a griglia arrotolabile, da installare in appoggio sul pavimento esistente
Porta	In cristallo temperato. Luce netta di passaggio cm 70x199. Spessore: 8mm
Forma delle panche	Sospese
Materiale delle panche	Legno atermico Abachi a doghe larghe
Illuminazione	Lampada con plafoniera in legno
Colore della luce	Bianco caldo 2700°K
Prodotti di consumo	Inclusa essenza Stenal Classic 0,5l
A cura del cliente	Pavimento perfettamente orizzontale e planare, rivestito in materiale lavabile (consigliato: gres porcellanato), allacciamento elettrico in corrispondenza del quadro elettrico
Manutenzioni periodiche	Pulizia con un panno bagnato e poche gocce di Destacryl (consigliato)
Normativa	CE; su richiesta ETL per alcuni modelli
Produzione	Made in Italy

## Datasheet: sauna Elegant

Features	Finnish sauna
Temperature	60 – 90°C
Humidity	10 – 15%
Heating system	Electric heater suitable for professional continuous usage
Control system	External controls
Voltage	Standard 400V 3-phase, optional 230V 1-phase
Power consumption	Depending on size
Walls material	Natural dried Swedish Fir. This wood, traditionally used in Northern Europe to make saunas, has a characteristic warm and welcoming look.
Walls decoration	Horizontal boards
Walls thickness	mm 68
Wood fragrance	●●○○○
Floor	Flexible grille, to be positioned on the existing floor
Door	Tempered glass. Door clearance: 70x199 cm. Thickness: 8mm
Bench design	Suspended
Bench material	Wide boards of athermic Abachi wood
Lighting	Wall-mounted light with wood lampshade
Light colour	Warm white 2700°K
Included	Fragrance Stenal Classic 0,5l
Preparations by Others	Perfectly level floor, covered in washable material (we recommend ceramic tiles), power supply next to the electric panel
Regular maintenance	Clean using a wet cloth and a few drops of Destacryl (recommended)
Norms	CE, on request ETL on select models
Production	Made in Italy

# Antique incasso | *built-in*





Pareti: Legno di Abete antico

*Walls: Antique Fir*

scala 1:1

*scale 1:1*

Panche: Ayous atermico

*Benches: Ayous athermic wood*

scala 1:1

*scale 1:1*



## Scheda tecnica: sauna Antique

Funzioni	Sauna finlandese
Temperatura	60 – 90°C
Umidità relativa	10 – 15%
Sistema di riscaldamento	Stufa elettrica adatta per uso professionale continuativo
Sistema di controllo	Tastiera esterna remotabile
Tensione elettrica	Standard 400V trifase, su richiesta 230V monofase
Potenza elettrica	A seconda delle dimensioni
Materiale pareti	Legno di Abete, recuperato da antichi masi di montagna; stagionato dal tempo nel corso di decenni e sapientemente lavorato per trasformarlo in una sauna. Ogni tavola è unica e racconta una storia a sé, per questo motivo colore e caratteristiche possono variare anche di molto tra una tavola e l'altra.
Decoro pareti	Doghe orizzontali
Spessore pareti	mm 80 ÷ 100
Profumo del legno	●●○○○
Pavimento	In legno, a griglia rigida, da installare in appoggio sul pavimento esistente
Porta	In cristallo temperato. Luce netta di passaggio cm 70x199. Spessore: 8mm
Forma delle panche	Sospese
Materiale delle panche	Legno atermico Abachi a doghe larghe
Illuminazione	Led lineari dietro schienale e sotto panca
Colore della luce	Bianco caldo 2700°K
Prodotti di consumo	Inclusa essenza Stenal Classic 0,5l
A cura del cliente	Pavimento perfettamente orizzontale e planare, rivestito in materiale lavabile (consigliato: gres porcellanato), allacciamento elettrico in corrispondenza del quadro elettrico
Manutenzioni periodiche	Pulizia con un panno bagnato e poche gocce di Destacryl (consigliato)
Normativa	CE; su richiesta ETL per alcuni modelli
Produzione	Made in Italy

## Datasheet: sauna Antique

Features	Finnish sauna
Temperature	60 – 90°C
Humidity	10 – 15%
Heating system	Electric heater suitable for professional continuous usage
Control system	External controls
Voltage	Standard 400V 3-phase, optional 230V 1-phase
Power consumption	Depending on size
Walls material	Fir wood reclaimed from antique constructions on the Italian mountains; aged by decades and expertly adapted and shaped into a sauna. Each board is unique and tells its own tale, for this reason colour and design may vary significantly between boards.
Walls decoration	Horizontal boards
Walls thickness	mm 80 ÷ 100
Wood fragrance	●●○○○
Floor	Rigid wooden grille, to be positioned on the existing floor
Door	Tempered glass. Door clearance: 70x199 cm. Thickness: 8mm
Bench design	Suspended
Bench material	Wide boards of athermic Abachi wood
Lighting	Linear LED lights behind the backrest and below the bench
Light colour	Warm white 2700°K
Included	Fragrance Stenal Classic 0,5l
Preparations by Others	Perfectly level floor, covered in washable material (we recommend ceramic tiles), power supply next to the electric panel
Regular maintenance	Clean using a wet cloth and a few drops of Destacryl (recommended)
Norms	CE, on request ETL on select models
Production	Made in Italy

# Configurazioni

# Configurations

Freestanding SX  
Freestanding Left



Freestanding DX  
Freestanding Right



Freestanding Vetrata SX  
Freestanding Glaze Left



Freestanding Vetrata DX  
Freestanding Glaze Right



Incasso SX  
Built-in Left



Incasso DX  
Built-in Right

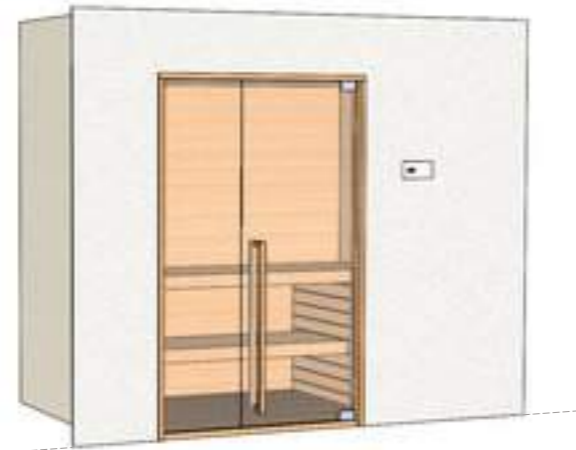

Incasso Vetrata SX  
Built-in Glaze Left



Incasso Vetrata DX  
Built-in Glaze Right

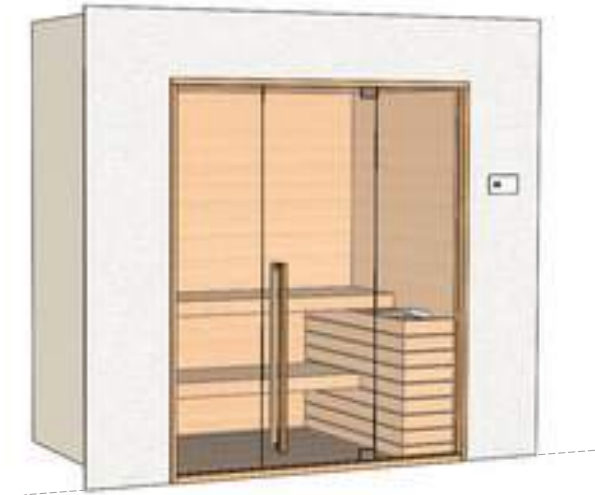

Corner SX  
Corner Left



Corner DX  
Corner Right



Corner Vetrata SX  
Corner Glaze Left



Corner Vetrata DX  
Corner Glaze Right



S

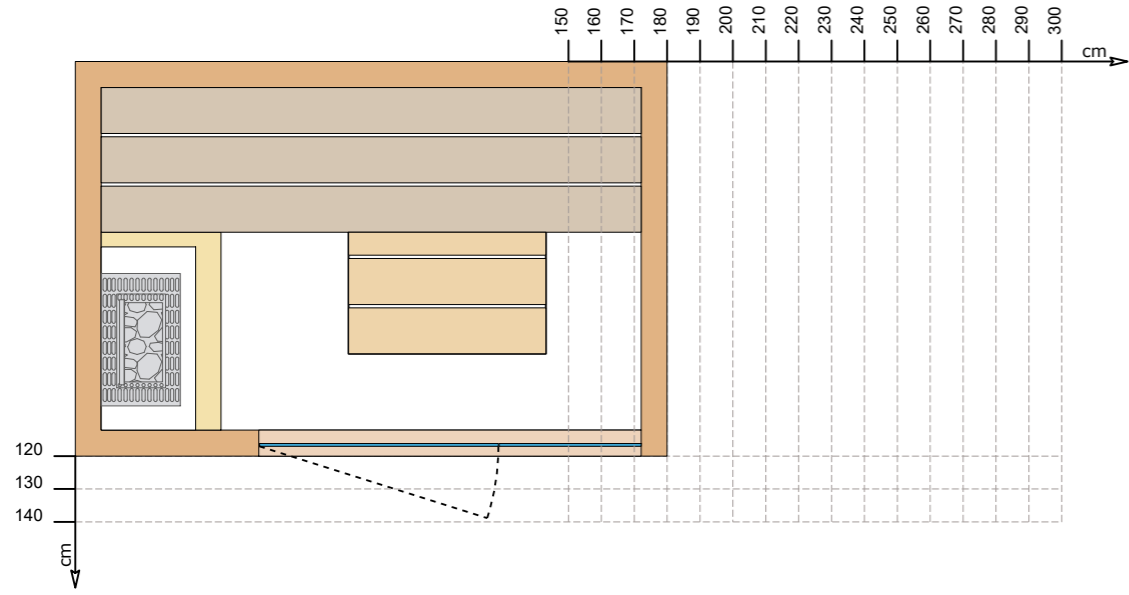

M

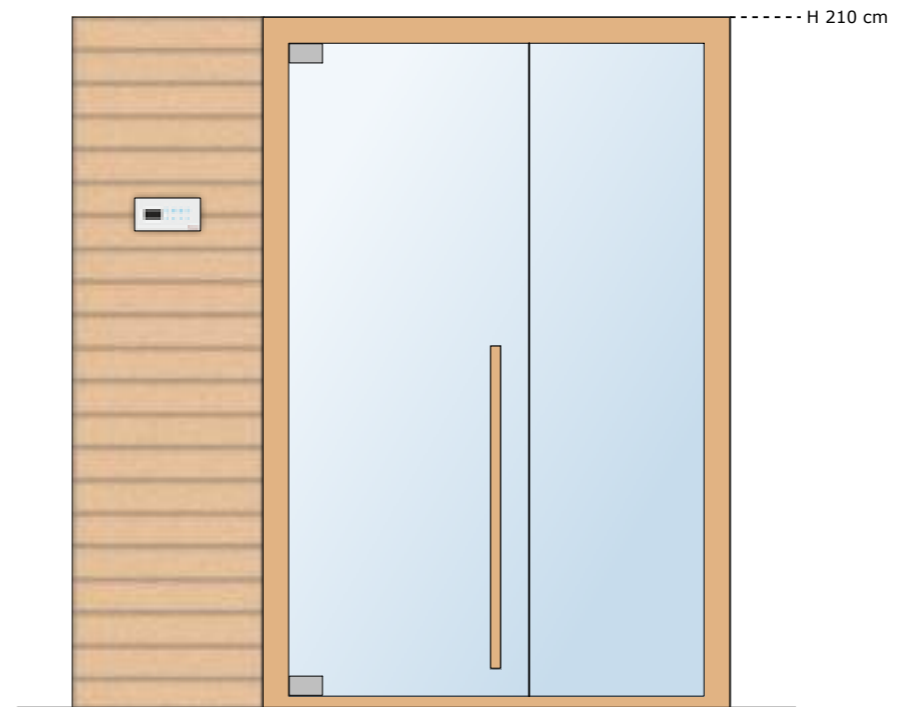
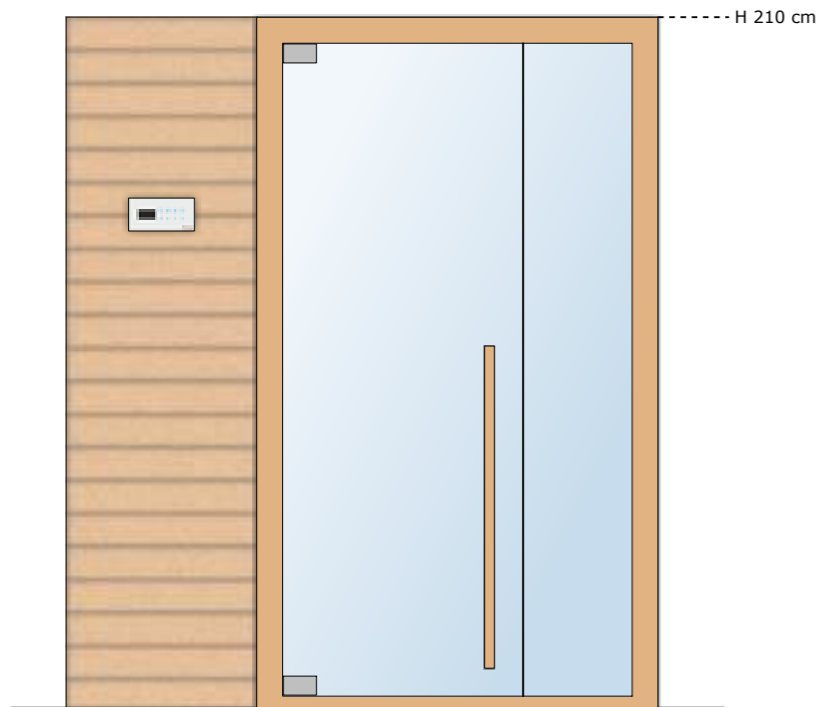
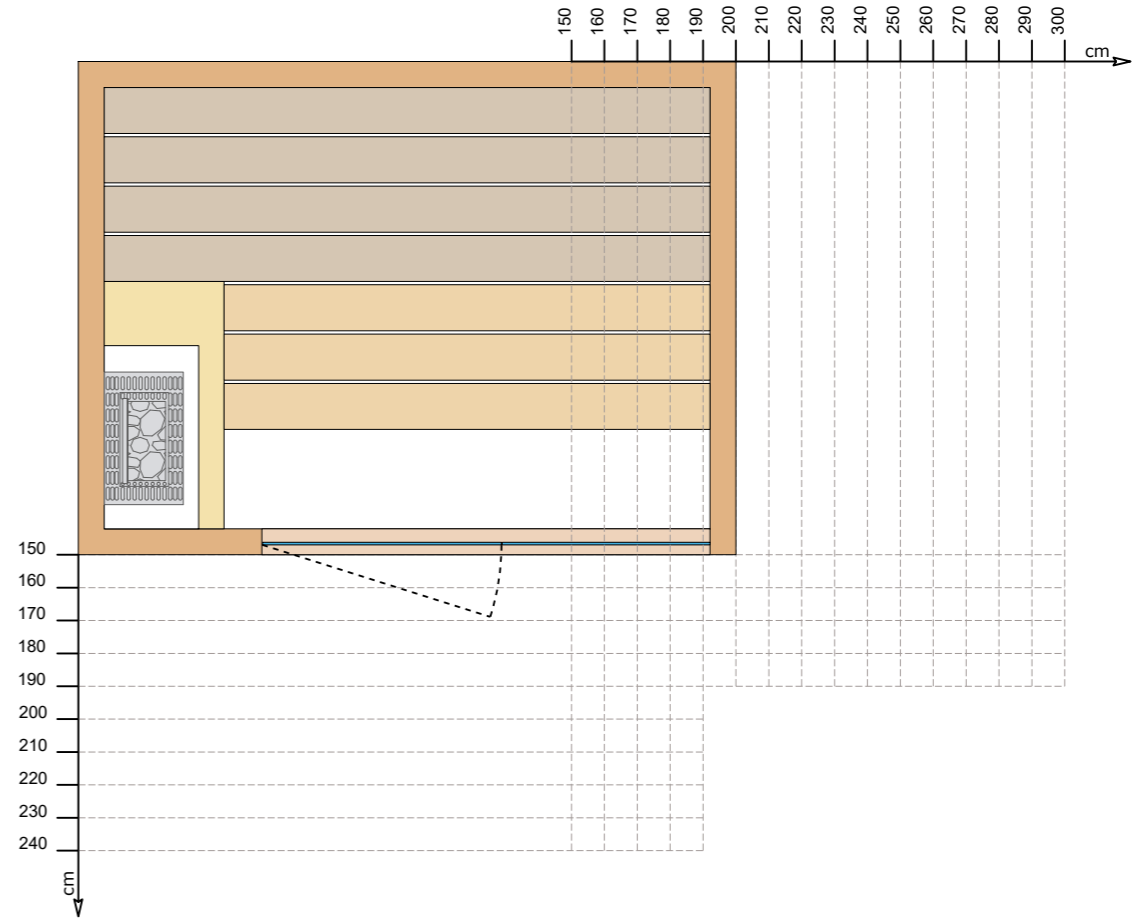

L

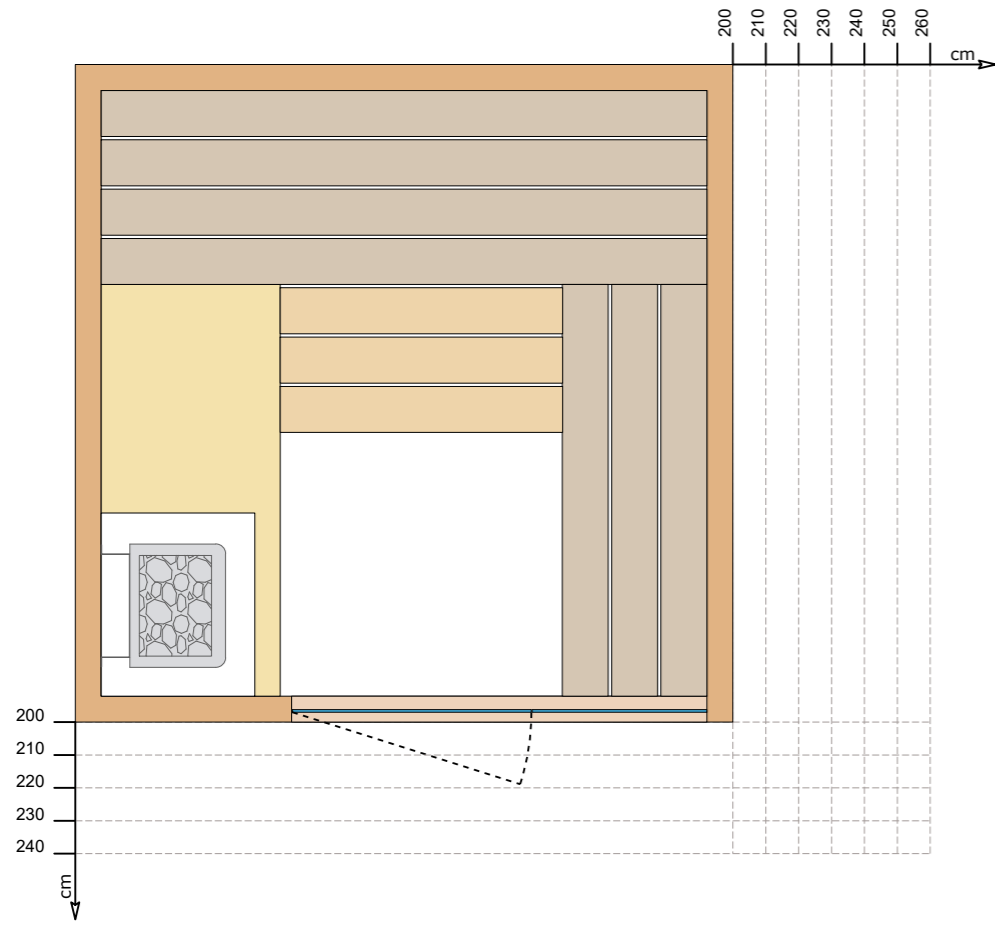

XL

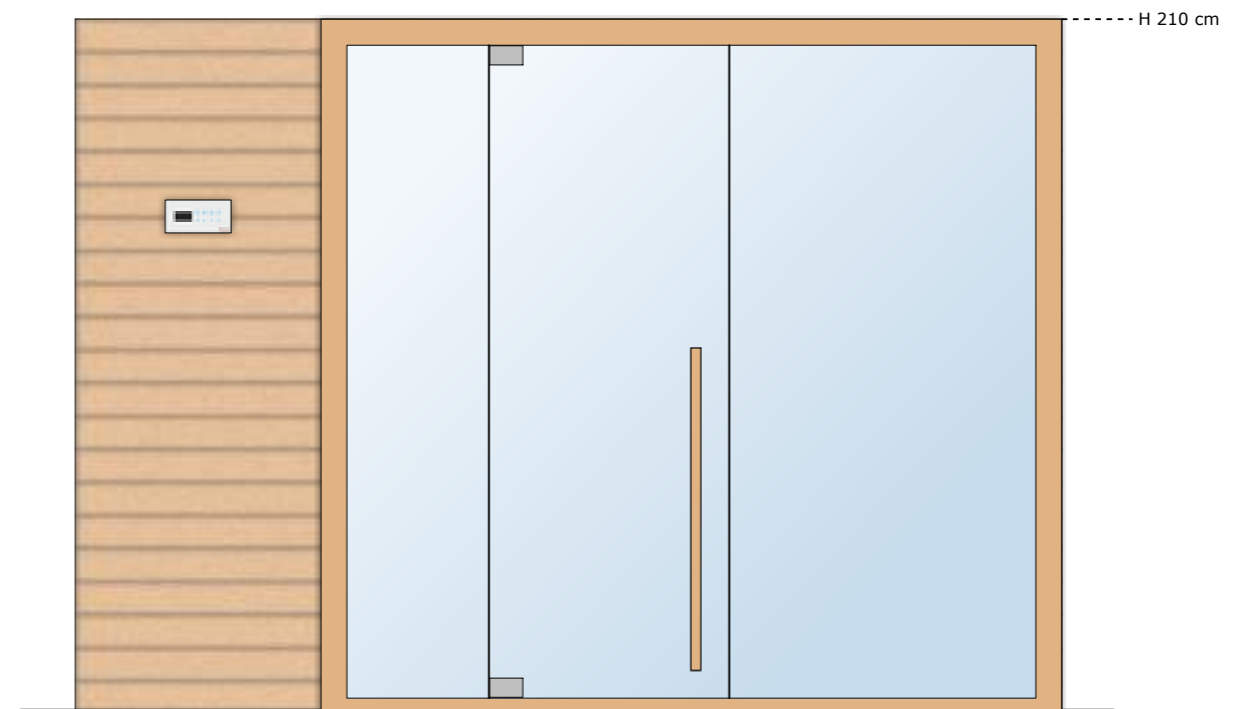
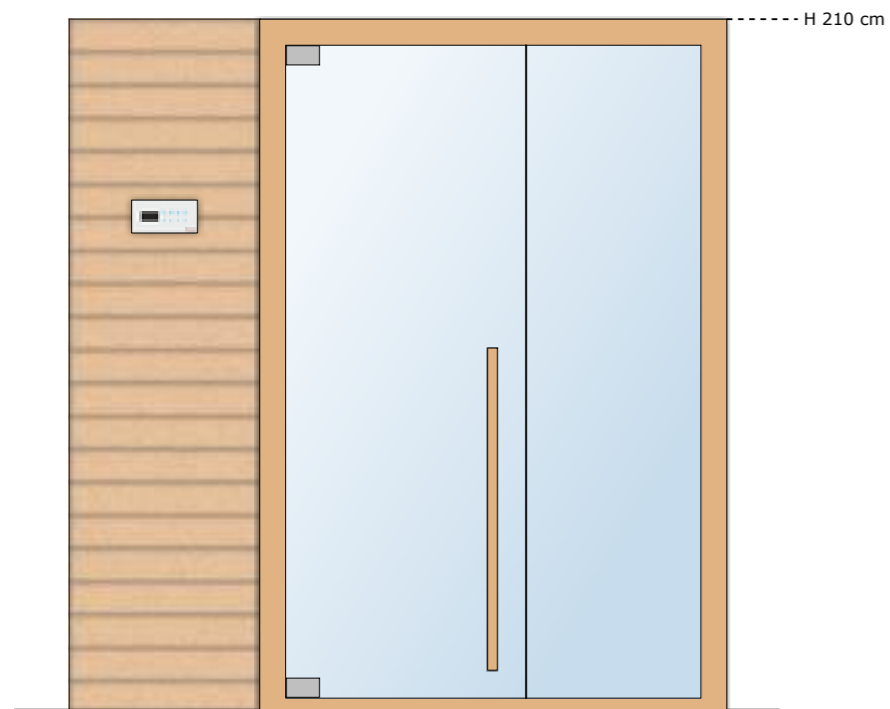
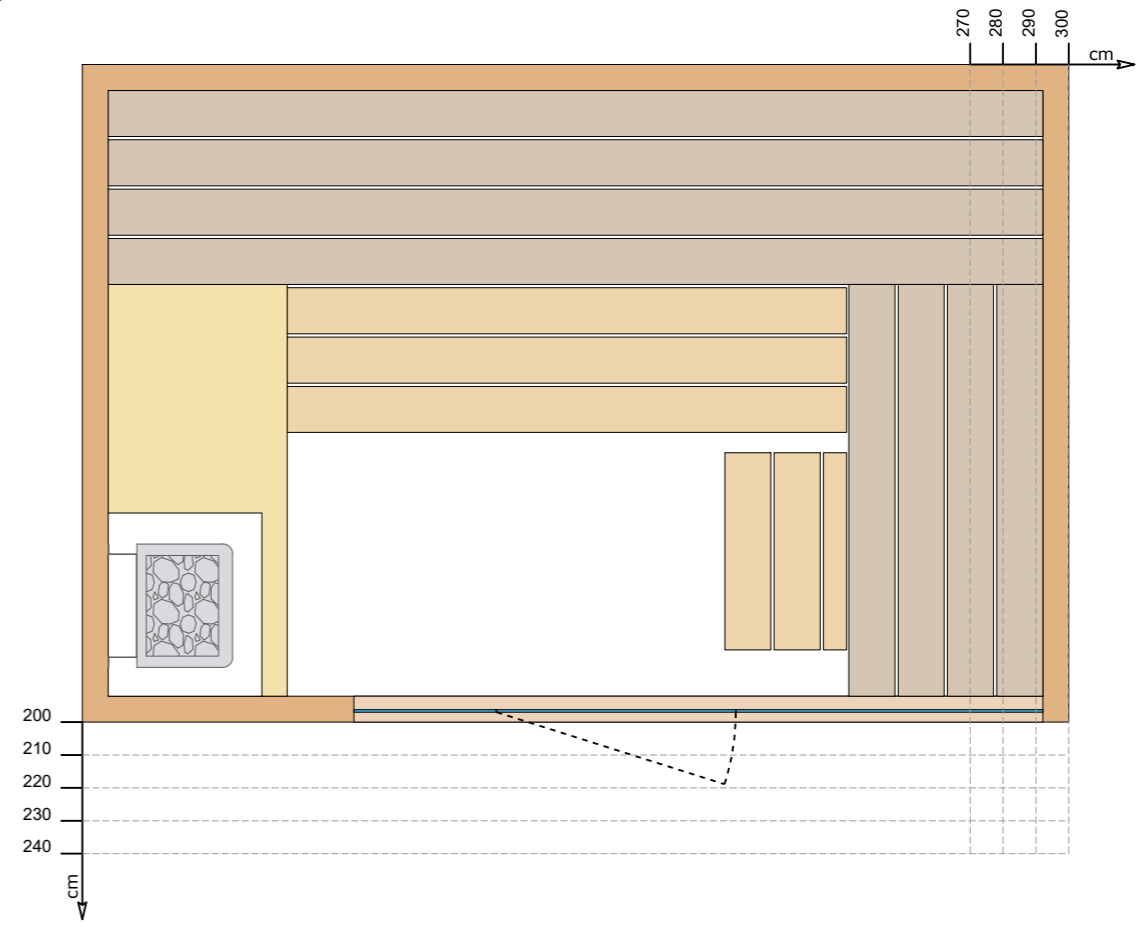

PRO

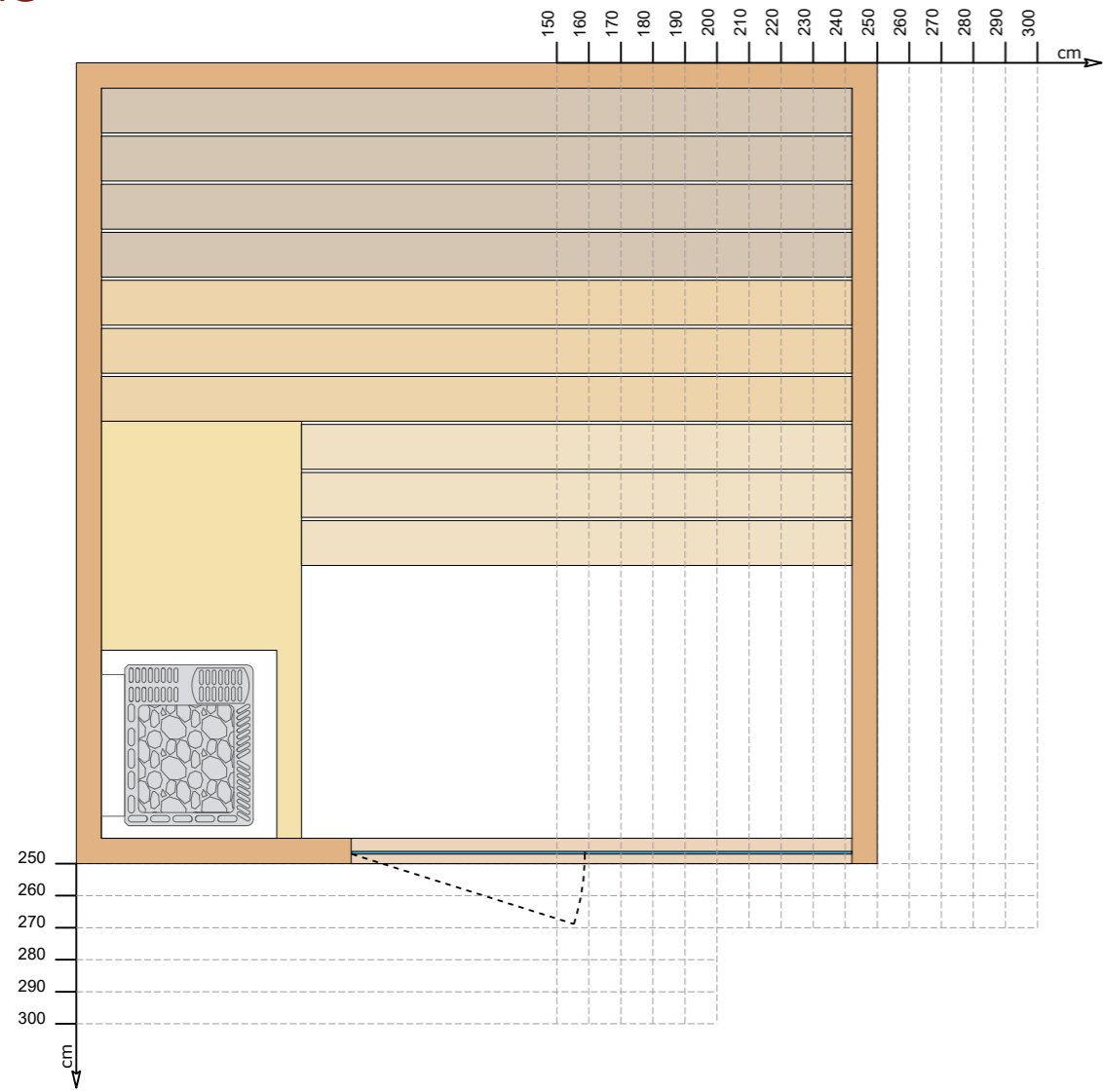



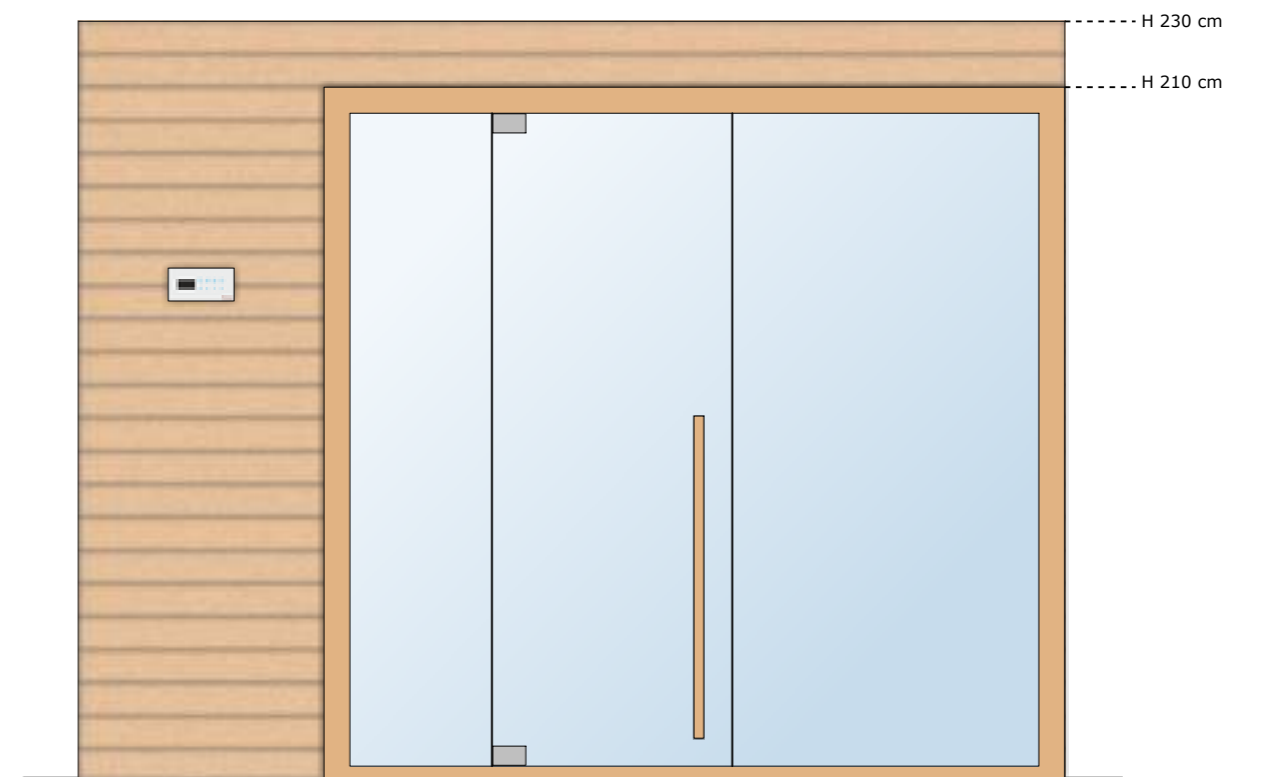
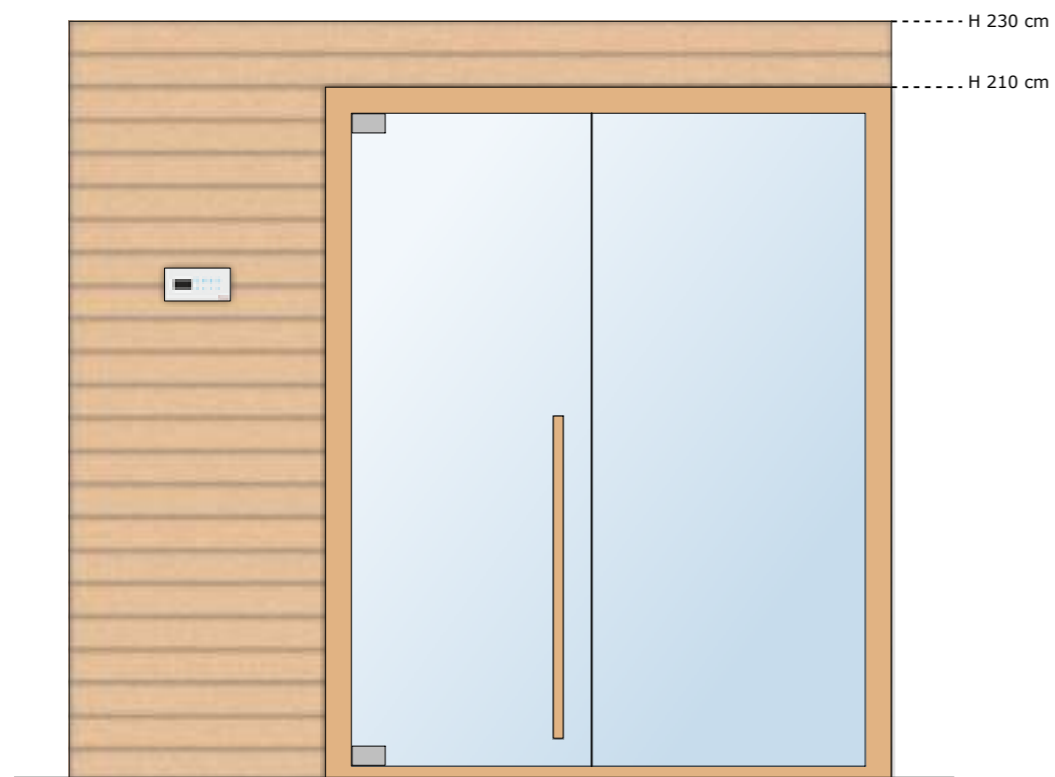
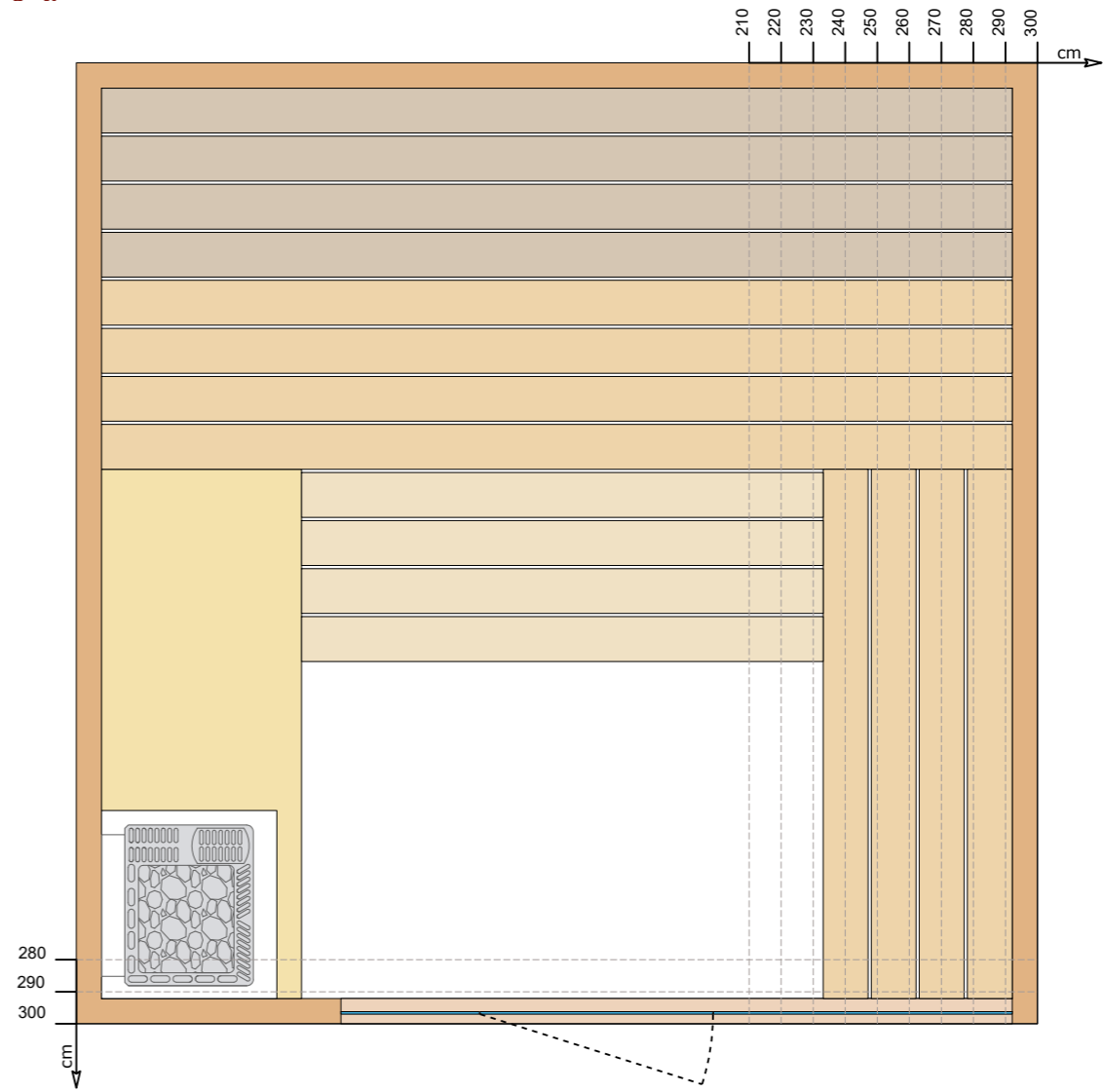















MAXI



## Funzioni e dotazioni



















Elite Evolution    Topclass Antique    Elegant

	Centralina Touch (uso domestico)	●	●	●
	Mastello, mestolo, poggiatesta	●	●	●
	Termoigrometro, clessidra	●	●	●
	Lati a vista come da configurazioni: incasso / freestanding / corner	●	●	●
	Casse audio	○	○	○
	Bluetooth	○	○	○
	Aroma	○	○	○
	Biosauna	○	○	○
	Infrarossi	○	○	○
	Pulsante di chiamata	○	○	○
	Pulsante di arresto	○	○	○
	Protezione stufa e predisposizione per comando remoto	○	○	○
	SmartSpa System Interfaccia Alexa / Google Home	○	○	○
	Illuminazione perimetrale bianco caldo	●	○	○
	Cielo stellato illuminazione RGB	○	○	○
	Luce dietro schienale bianco caldo	-	●	○
	Luce sotto panca bianco caldo	○	●	○
	Lampada classica	○	○	●

- Incluso di serie
- Optional
- Non compatibile

## Functions and features

Elite Evolution    Topclass Antique    Elegant

	Control unit Touch (private use)	●	●	●
	Bucket, ladle, headrest	●	●	●
	Thermo-hygrometer, hourglass	●	●	●
	External sides as per configurations: built-in / freestanding / corner	●	●	●
	Loudspeakers	○	○	○
	Bluetooth	○	○	○
	Aroma	○	○	○
	Biosauna	○	○	○
	Infrared	○	○	○
	Call button	○	○	○
	Stop button	○	○	○
	Heater protection and interface for remote control	○	○	○
	SmartSpa System Alexa / Google Home interface	○	○	○
	Warm white perimeter lighting	●	○	○
	Starry sky RGB lighting	○	○	○
	Warm white light behind the backrest	-	●	○
	Warm white light below the bench	○	●	○
	Classic lamp	○	○	●

- Included
- Optional
- Not available

## Il sistema di riscaldamento delle saune finlandesi

### *Finnish sauna heating system*



#### Heat Slim

Stufa di piccole dimensioni, contiene fino a 10 kg di pietre peridotitiche.  
Potenze disponibili: 3,0 / 4,5 Kw.

*A small-size heater that can contain up to 10 kg of peridotite rocks.  
Power options: 3.0 / 4.5 Kw.*



#### Heat PRO

Stufa di medie dimensioni; contiene fino a 15 kg di pietre peridotitiche.  
Potenze disponibili: 4,5 / 6,0 / 7,5 / 9,0 Kw.

*A medium-size heater that can contain up to 15 kg of peridotite rocks.  
Power options: 4.5 / 6.0 / 7.5 / 9.0 Kw.*



#### Heat Plus

Stufa di grandi dimensioni; contiene fino a 60 kg di pietre peridotitiche.  
Potenze disponibili: 12,0 / 15,0 Kw.

*A large-size heater that can contain up to 60 kg of peridotite rocks.  
Power options: 12.0 / 15.0 Kw.*

## Il sistema di riscaldamento delle biosaune

### *Bio sauna heating system*



#### Heat Slim Bio

Stufa di piccole dimensioni, contiene fino a 10 kg di pietre peridotitiche.  
Potenze disponibili: 3,0 / 4,5 Kw.

*A small-size heater that can contain up to 10 kg of peridotite rocks.  
Power options: 3.0 / 4.5 Kw.*



#### Heat PRO Bio

Stufa di medie dimensioni; contiene fino a 15 kg di pietre peridotitiche.  
Potenze disponibili: 4,5 / 6,0 / 7,5 / 9,0 Kw.

*A medium-size heater that can contain up to 15 kg of peridotite rocks.  
Power options: 4.5 / 6.0 / 7.5 / 9.0 Kw.*



#### Heat Plus Bio

Stufa di grandi dimensioni; contiene fino a 60 kg di pietre peridotitiche.  
Potenze disponibili: 12,0 / 15,0 Kw.

*A large-size heater that can contain up to 60 kg of peridotite rocks.  
Power options: 12.0 / 15.0 Kw.*



**Illuminazione perimetrale a soffitto**

In un ambiente dedicato al perfetto relax di corpo e mente la luce gioca un ruolo fondamentale: i punti luce bianco caldo disposti a soffitto lungo il perimetro della sauna illuminano e scaldano lo spazio con eleganza e accentuano il prestigio dei materiali.



**Ceiling perimeter lighting**

*In an environment devoted to body and mind relaxation, light plays an essential role: warm white spots of light along the perimeter of the ceiling bring light, warmth and style to the sauna and emphasise the quality of the materials.*

**Cielo stellato con chromoLux**

La disposizione a soffitto di una miriade di puntini luminosi che passano delicatamente da un colore all'altro crea inediti effetti di luce e atmosfere personalizzabili grazie alla possibilità di fermo colore. La speciale tecnologia a fibre ottiche garantisce un sistema silenzioso e resistente alle alte temperature che si formano a soffitto nelle saune, assicurando un'atmosfera suggestiva e rilassante.



**Starry sky with chromoLux**

*Multiple tiny colour-changing spots of light fitted in the ceiling to create unique light effects, with the option to control the colour settings and personalise the mood. The special fibre optics technology guarantees an extremely quiet lighting system, resistant to the high temperatures that form in a sauna ceiling, ensuring a striking atmosphere and a relaxing experience.*

**Schienale retroilluminato**

Una luce continua e omogenea dietro lo schienale della panca superiore proietta verso l'alto un'illuminazione soffusa e indiretta, che gioca con la texture dei materiali ed enfatizza la tridimensionalità dei volumi.



**Backlit backrest**

*A constant and homogeneous light behind the bench backrest projects a soft, indirect light on the ceiling emphasising the texture of the materials and three-dimensional shapes.*

**Illuminazione sotto panca**

L'illuminazione rivolta verso il basso dona un effetto scenografico e accattivante. La luce indiretta mantiene l'atmosfera di quieta intimità dell'ambiente.

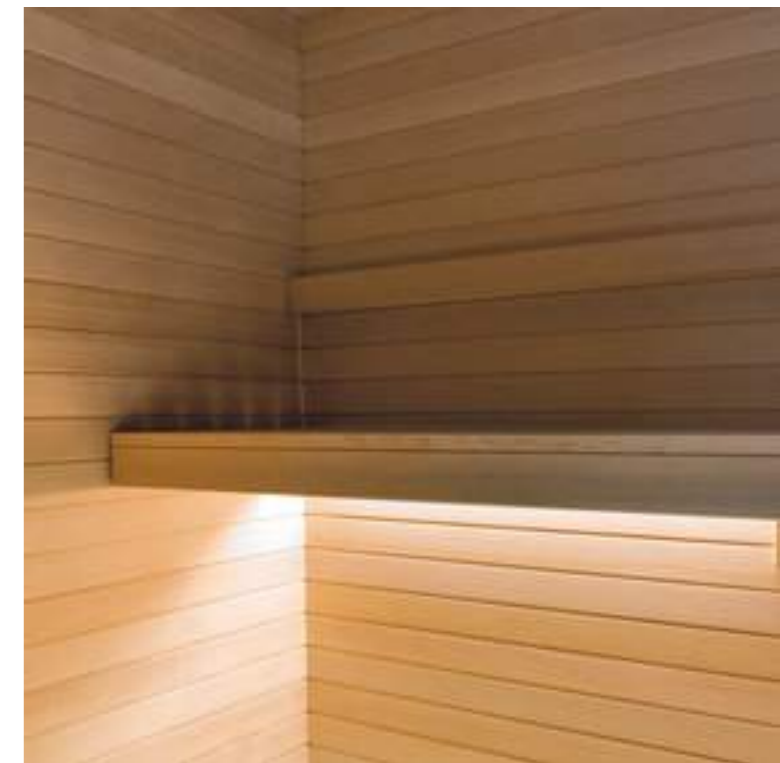

**Under-bench lighting**

*The down-facing lights create an evocative and suggestive effect. The indirect light endows the sauna with quiet intimacy.*

**Mastello e mestolo**

Il tradizionale mastello, abbinato al mestolo in legno, permette di versare l'acqua aromatizzata con essenze balsamiche sopra le pietre laviche allo scopo di aumentare temporaneamente l'umidità nella cabina.



**Bucket and ladle**

The traditional wood bucket and matching ladle, used to pour water scented with soothing aromas over the rocks to temporarily increase the humidity in the cabin.

**Termoigrometro**

Indicatore di temperatura e umidità per sauna, specifico per le alte temperature. Le lancette indicano la temperatura da 20°C a 120°C e la percentuale di umidità da 0% a 70%.



**Thermo-hygrometer**

Sauna temperature and humidity indicator, specific for high temperatures. The hands indicate the temperature between 20°C and 120°C and the percentage of humidity between 0% and 70%.

**Clessidra**

Clessidra con tre tacche segnatempo da 5 minuti, 10 minuti e 15 minuti, resistente alle alte temperature e coordinabile con la linea di accessori per sauna. Con elegante cornice in legno per l'affissione a parete, si intona perfettamente alle migliori saune finlandesi.



**Hourglass**

An hourglass that measures fifteen minutes in five minute increments, resistant to high temperatures, an ideal addition to the line of sauna accessories. With its elegant wood frame, it hangs on the wall and matches perfectly the style of the best Finnish saunas.

**Poggiatesta**

Cuscino per sauna ideale per un completo relax, l'accessorio tradizionale dal design moderno che consente una corretta e completa distensione della schiena e del collo, rendendo la permanenza in sauna ancora più piacevole.



**Headrest**

The ideal sauna headrest for total relaxation; a traditional accessory with a modern design that provides a correct and comfortable back and neck position and makes the sauna session even more enjoyable.

Centralina remotabile Touch

Centralina **100% Made in Italy**. La perfetta combinazione di design e tecnologia. Compatibilità con accensione domotica. Misure cm 20x10.



Touch control unit

Control unit **100% Made in Italy**. Combines high end design and cutting edge technology. Compatible with home automation systems. Size: 20x10 cm.

Casse audio

Casse audio per sauna collegabili ad un impianto di filodiffusione esterno.



Loudspeakers

Loudspeakers which can be connected to an external audio source.

Bluetooth

Ricevitore bluetooth per controllare la musica direttamente dal tuo smartphone.

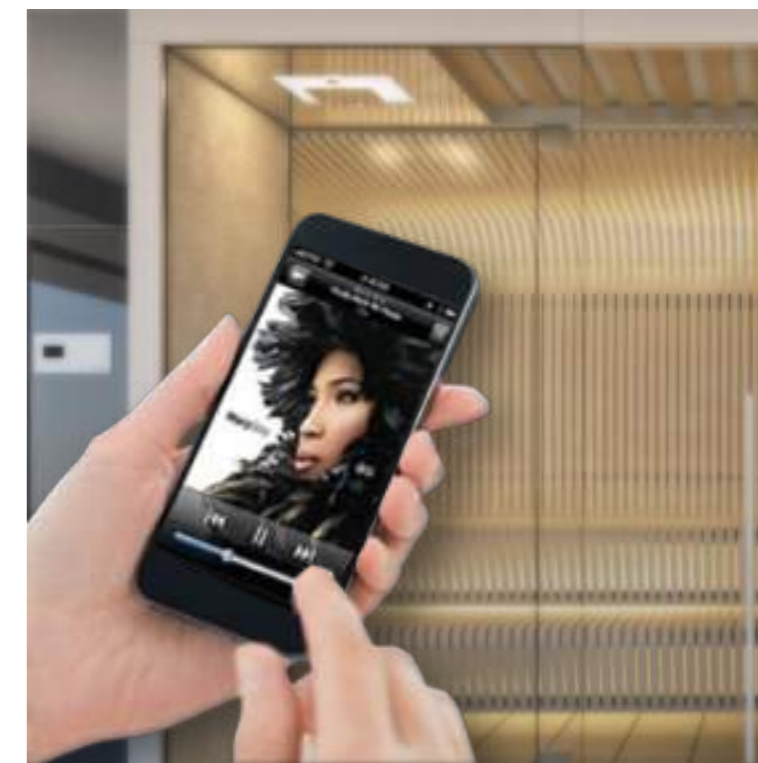

Bluetooth

Bluetooth receiver, to control music from your smartphone.

**Dosatore automatico di acqua & aromi**

Nella sauna le essenze rivestono un ruolo molto importante: attraverso l'olfatto, uno dei sensi umani più sviluppati, comunicano emozioni piacevoli, stimolanti o rilassanti. Il dosatore automatico permette di avere sempre la quantità ideale di acqua e aromi in sauna.

**Automatic doser of water & aroma**

Aromas play a very important role in saunas: through smell, one of our most developed senses, we perceive pleasant, stimulating and relaxing sensations. The automatic doser maintains the right amount of water and aromas in the sauna at all times.

**Sensore di sicurezza**

Il sensore inibisce l'accensione della stufa se viene appoggiato un oggetto sopra le pietre, o se teli e asciugamani vi rimangono a contatto.

**Safety sensor**

This sensor prevents the heater from switching on if any objects are placed on the rocks, or if towels are in contact with it.

**Pulsante di chiamata**

Pulsante di chiamata resistente alle alte temperature, da collegare a una suoneria esterna (non fornita).

**Call button**

A button that can withstand high temperatures; must be connected to an external signal (not provided).

**Pulsante di arresto**

Pulsante di arresto, interrompe l'alimentazione alla stufa quando premuto. Va riarmato manualmente sul posto. Può anche essere collegato ad una suoneria esterna (non fornita).

**Stop button**

Interrupts power to the heater when pressed. Needs to be rearmed manually. It can also be connected to an external buzzer (not supplied).

# Infrarossi

*infrared*





### Postazioni infrarossi

Una o più postazioni infrarossi possono essere aggiunte ad una normale sauna finlandese. Il risultato è una sauna "Combi". Gli infrarossi possono essere utilizzati sia da soli, sia in contemporanea alla stufa.



### Infrared emitters

One or more infrared emitters can be added to a normal finnish sauna. The result is a "Combi" sauna. The infrared can be used either alone or simultaneously with the heater.

### Infrarossi di qualità

Stenal usa emettitori infrarossi **Philips™ Vitae**, che offrono la migliore combinazione di raggi infrarossi IR-A, IR-B e IR-C e scaldano il tessuto sottocutaneo dall'interno fino a 5mm in profondità.



### Quality infrared

Stenal uses **Philips™ Vitae** infrared lamps, which offer the best IR-A, IR-B and IR-C infrared ray combination and heat the skin's lower layers up to 5mm deep.

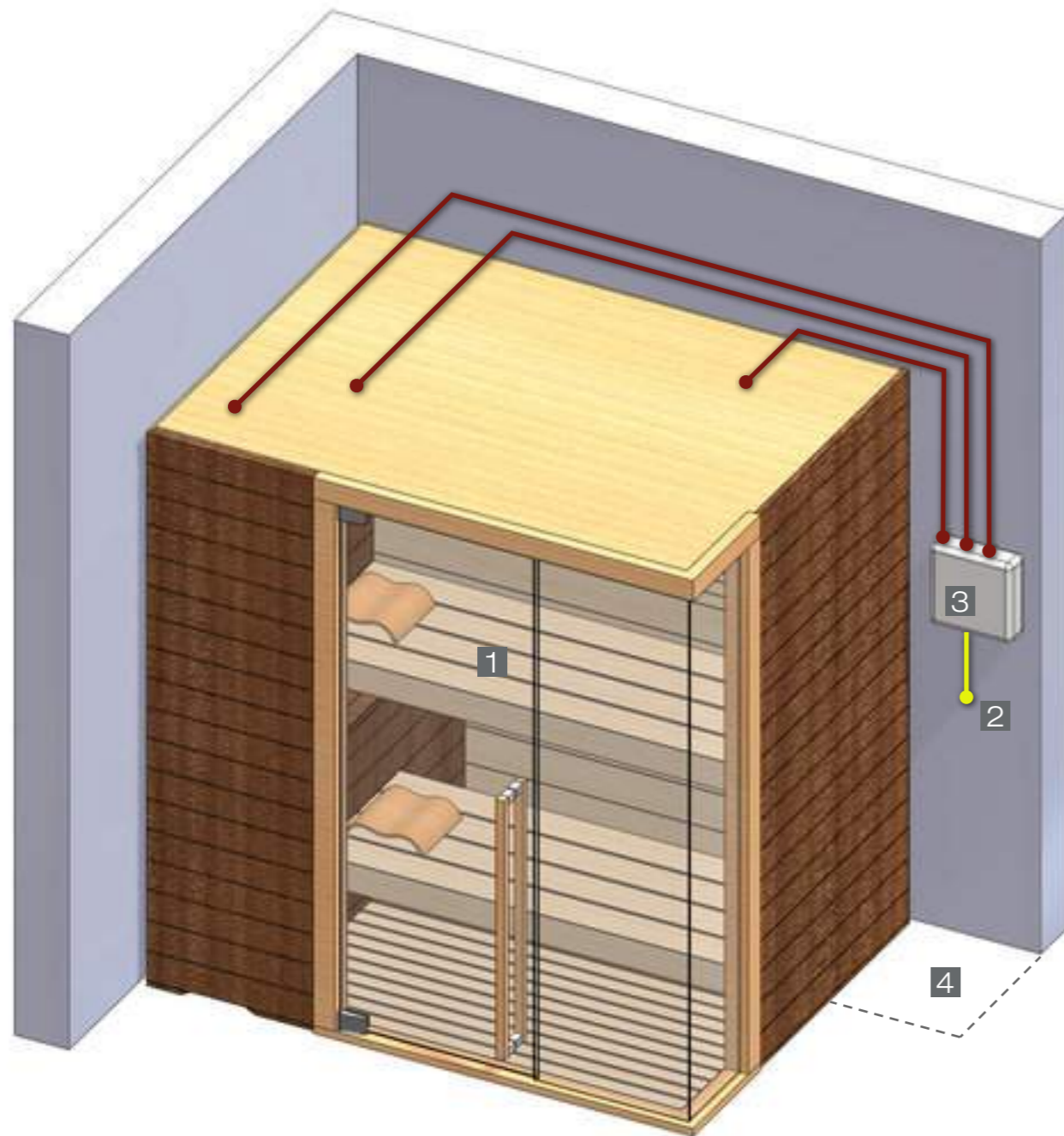

- 1 Sauna  
*Sauna*
- 2 Allacciamento elettrico  
*Power supply*
- 3 Centralina + display  
*Control unit + display*
- 4 Vano tecnico  
*Plant room*

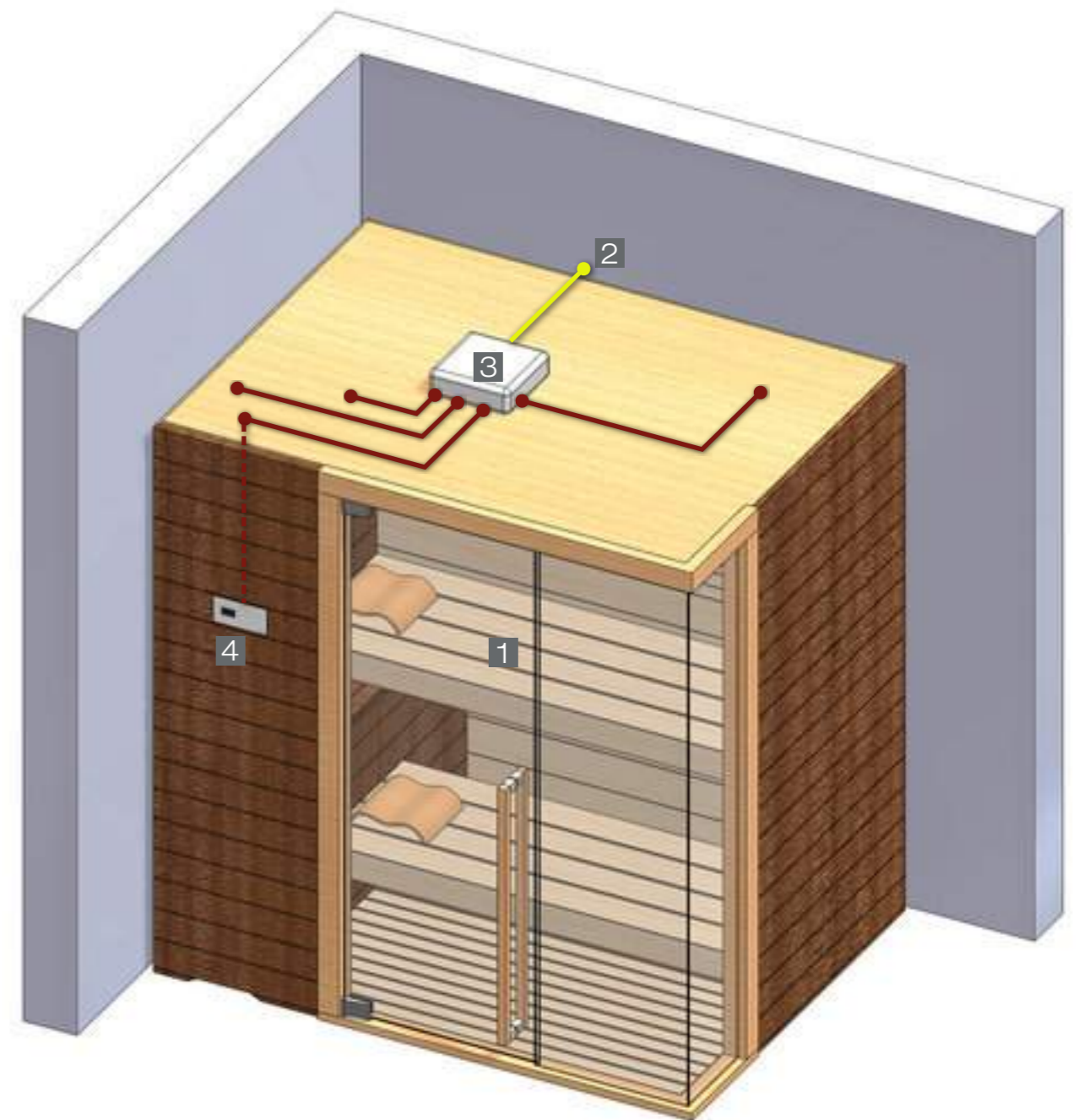

- 1 Sauna  
*Sauna*
- 2 Allacciamento elettrico  
*Power supply*
- 3 Centralina  
*Control unit*
- 4 Display  
*Display*

# Horizon

*Outdoor*







La sauna da esterni Horizon unisce la qualità italiana alla rapidità di installazione.

La vetrata panoramica consente una vista a 180 gradi sull'ambiente esterno, donando agli ospiti un'esperienza da raccontare.

La veranda completa l'esperienza, offrendo un comodo appoggio dove cambiarsi, ma è possibile anche non prevederla.

Il legno di cedro è profumato, non assorbe gli odori ed è molto resistente.

*The Horizon outdoor sauna combines Italian quality with fast installation.*

*The panoramic window allows a 180 degree view of the landscape, offering to guests an unforgettable experience.*

*The veranda is designed to offer a comfortable place where to change, but it is also possible to order the sauna without this element.*

*Cedar wood is naturally fragrant, impermeable to odors and very resistant*



Horizon occupa poco spazio e offre un'ampia flessibilità nella collocazione: non servono coperture.

*Horizon is compact and offers great flexibility for positioning. There is no need for external covers.*



Si installa in poche ore, perché viene trasportata già montata.

*It can be installed quickly, because we ship it preassembled.*



La sauna Horizon può essere compresa di stufa elettrica oppure a legna.

*Horizon sauna can be equipped with electric heater or wood-burning heater.*



La sua conformazione a botte la rende resistente al carico neve e veloce da riscaldare.

*Its barrel shape makes it resistant to snow loading and quick to heat up.*



M

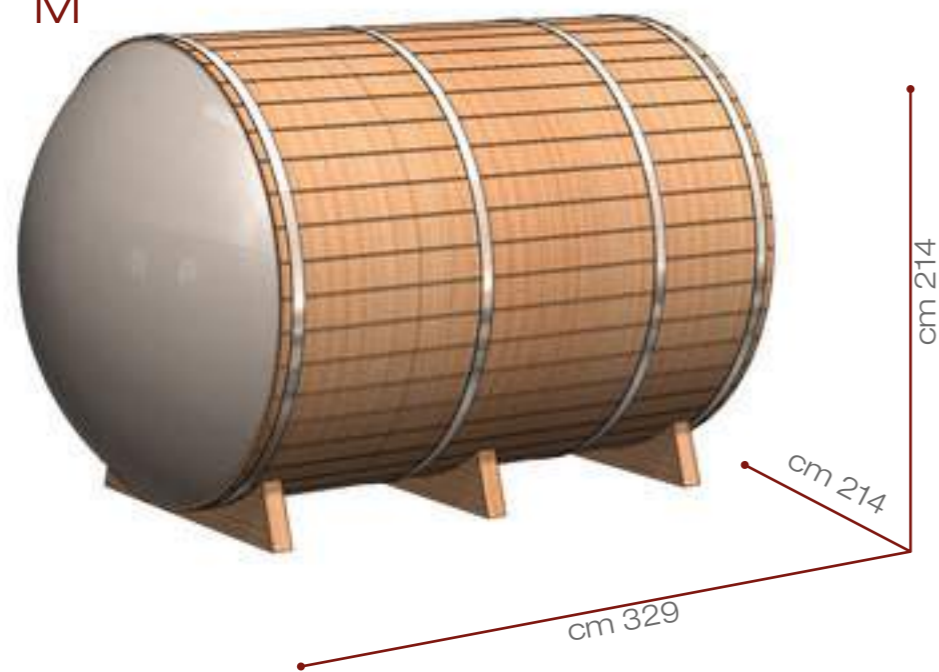

-  5x
-  2x
-  7,5 kW / 400V
-  700 Kg

L

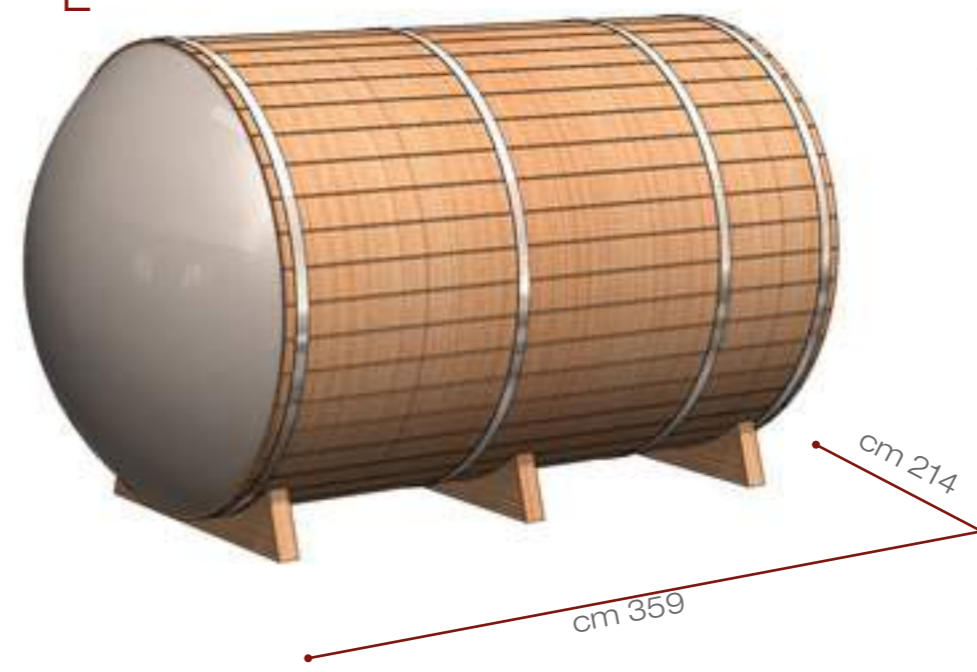

-  7x
-  2x
-  9,0 kW / 400V
-  800 Kg



il tepore dei bagni turchi  
*steam warmth experiences*

# SteamCustom

Il bagno turco completamente personalizzabile

*The fully tailored steam experience*





Bagno turco con Aromarium  
*Aroma steam room*



Bagno turco con effetti luce Aurora  
*Steam room with Aurora light effect*



Bagno turco con effetto luce Tramonto

*Steam room with Sunset light effect*

ZeroNero Fitness Club, Bergamo, Italy



Bagno turco con panche riscaldate  
*Steam room with heated benches*



Incastri maschio/femmina per facilità di montaggio e garanzia di tenuta  
 Tongue and groove system for easy assembling and insulation guarantee

Incastri maschio/femmina per facilità di montaggio e garanzia di tenuta  
 Tongue and groove system for easy assembling and insulation guarantee

Tubo vapore coibentato, incasso a parete eseguito in fabbrica  
 Insulated steam pipe, factory-fitted inside the wall

Distribuzione elettrica e idraulica progettata e installata in fabbrica  
 Hydraulic and electric distribution designed and installed at the factory

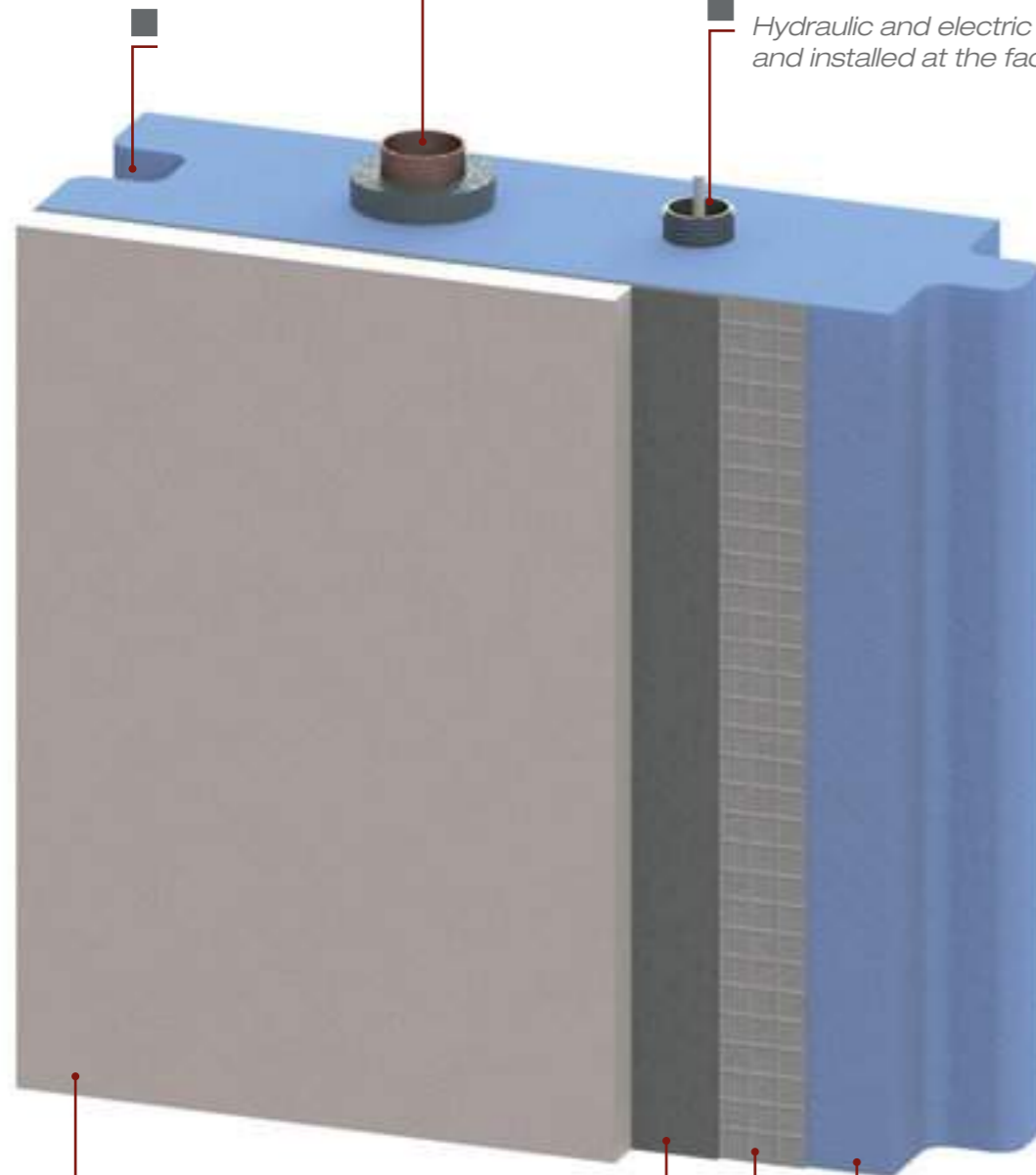

- A cura di Stenal  
By Stenal
- A cura del Cliente  
By Others

Pareti interne e panche: piastrelle o mosaico. Pareti esterne a vista: cartongesso, piastrelle o altro materiale. Soffitto: da verniciare o rivestire in mosaico.

Internal walls and benches: tiles or mosaic. External walls: plasterboard, tiles or other materials. Ceiling: to be painted or covered in mosaic tiles.

EPS ad alta densità 35 Kg / m<sup>3</sup>  
 High density EPS 35 Kg / m<sup>3</sup>

Rasatura cementizia con rete in fibra di vetro  
 Cement coating with fibreglass mesh

Impermeabilizzazione  
 Waterproofing

Esclusivo sistema Stenal QuickFix:

Stenal QuickFix è il sistema di montaggio veloce studiato appositamente per diminuire i tempi di lavorazione in cantiere. Ogni singolo componente è già stato collaudato precedentemente in fabbrica e tutti i pezzi si incastrano in modo veloce tra di loro per garantire un montaggio a regola d'arte. La cabina è autoportante e non richiede muri di contenimento.

Exclusive Stenal QuickFix System:

Stenal QuickFix is a system designed specifically to reduce the installation time on site. Each product is preassembled in advance at our factory so we can guarantee quick assembly and perfect fit. The cabin is self-supported and does not require supporting walls.

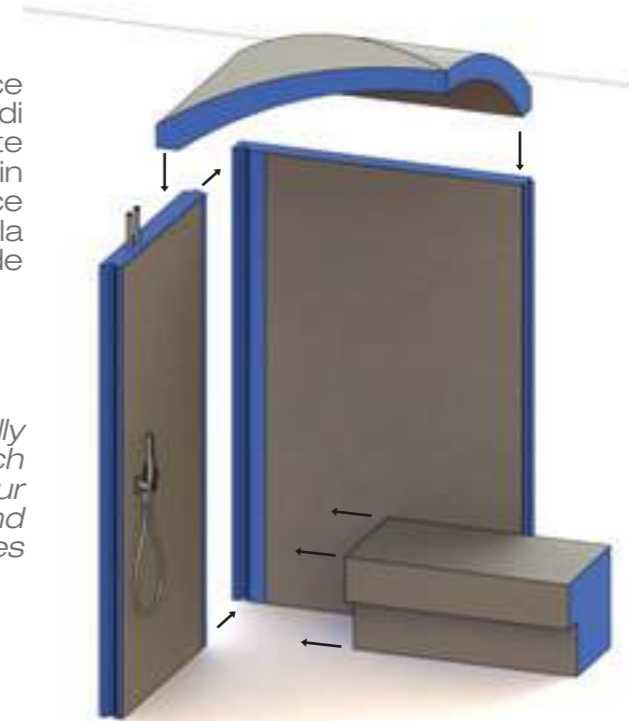

Montaggio sul massetto:  
 Installation on the screed:

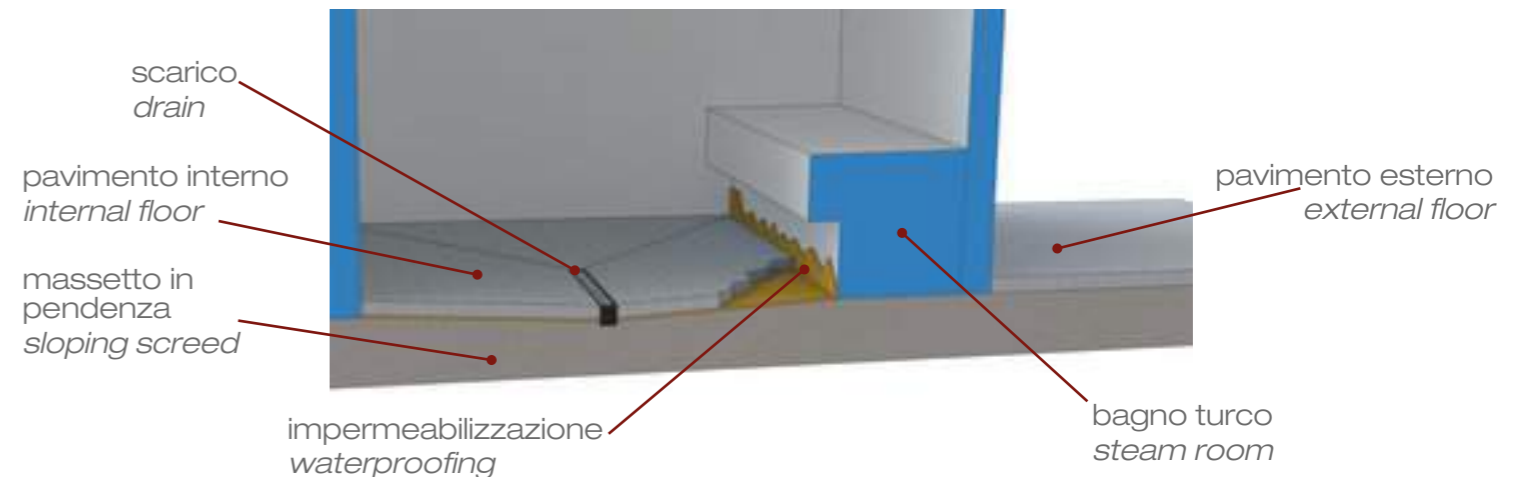

Ottimale distribuzione del vapore:

Progettiamo e realizziamo attentamente tutti i lavori impiantistici necessari, così che i pannelli arrivino completi con già incassate tutte le parti elettriche ed idrauliche, incluse luci e gruppi miscelatori, garantendo una corretta distribuzione del vapore dentro la cabina.

Optimal steam distribution:

We carefully design and execute all the piping and wiring in our factory, so the panels arrive complete with embedded insulated pipes for steam, hydraulic and electric preparations, including lighting and shower mixers, guaranteeing a correct distribution of steam in the room.

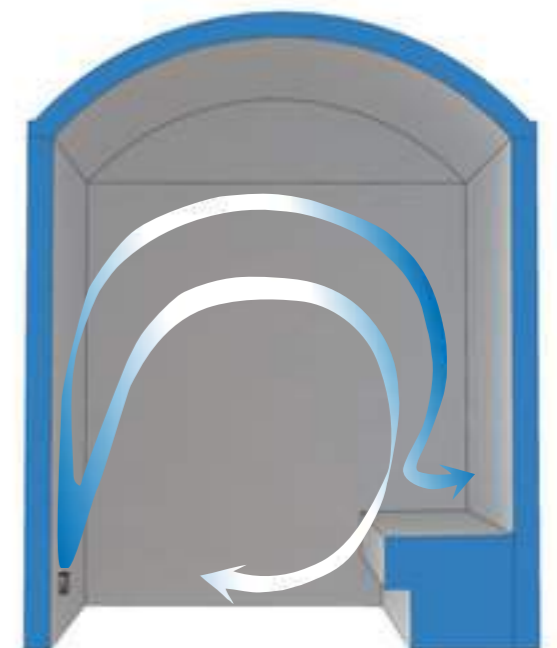

## Scheda tecnica: bagno turco SteamCustom

Funzioni	Bagno turco
Temperatura	40-45°C
Umidità relativa	98-100%
Sistema di riscaldamento	Generatore di vapore
Sistema di controllo	Tastiera esterna
Tensione elettrica	Standard 400V, su richiesta 230V fino a 6 kW
Potenza elettrica	A seconda delle dimensioni
Materiale pareti	EPS ad alta densità (35 Kg/m <sup>3</sup> ), rivestiti internamente ed esternamente con rete in fibra di vetro e rasatura cementizia
Spessore pareti	80-100 mm a seconda delle dimensioni, cabina autoportante
Pavimento	Struttura priva di pavimento, da incollare sul massetto. Optional pavimento spessore 13 cm con piletta raccordata su un lato a scelta
Porta	In cristallo temperato con telaio in alluminio. Luce netta di passaggio cm 70x199. Spessore: 8mm
Forma delle panche	Di serie panca tipo A. Altri modelli su richiesta
Materiale delle panche	EPS ad alta densità
Illuminazione	Strip-led sotto panca bianco caldo, 2700°K
Accessori in dotazione	Bocchetta uscita vapore in acciaio inox, doccia flessibile, incasso tubi a parete con raccordo sopra il soffitto, aroma manuale (Zephyr) o automatico (Pro-E / Pro-R)
Audio	Optional
Prodotti di consumo	Inclusa essenza Stenal Therm Fresh 0,5l
A cura del cliente	Massetto con piletta di scarico all'interno del bagno turco; allacciamento acqua, scarico e allacciamento elettrico nel vano tecnico. Dopo l'installazione: impermeabilizzazione e rivestimento
Allacciamento acqua	Acqua fredda, 2-4 bar, attacchi da 3/4" GAS UNI ISO 228/1
Manutenzioni periodiche	Pulizia frequente con prodotto igienizzante (consigliato: Destacryl), svuotamento calcare
Normativa	CE; su richiesta ETL per alcuni modelli
Produzione	Made in Italy

## Datasheet: steam room SteamCustom

<i>Features</i>	<i>Steam bath</i>
<i>Temperature</i>	<i>40-45°C</i>
<i>Humidity</i>	<i>98-100%</i>
<i>Heating system</i>	<i>Steam generator</i>
<i>Control system</i>	<i>External control</i>
<i>Voltage</i>	<i>Standard 400V, 230V up to 6 kW on request</i>
<i>Electric power</i>	<i>Depending on size</i>
<i>Walls material</i>	<i>High-density EPS (35 Kg/m<sup>3</sup>), coated internally and externally with fibreglass mesh and a cementitious layer</i>
<i>Wall thickness</i>	<i>80-100 mm depending on size, self-supporting cabin</i>
<i>Floor</i>	<i>The structure has no floor and will be glued to the screed. Optional floor, 13 cm thick, with drain linked to the side</i>
<i>Door</i>	<i>Tempered glass with aluminium frame. Door clearance: cm 70x199. Thickness: 8mm</i>
<i>Benches shape</i>	<i>Type A bench comes as standard. Other models upon request</i>
<i>Benches material</i>	<i>High-density EPS</i>
<i>Lighting</i>	<i>Warm white linear led below the bench, colour 2700°K</i>
<i>Included accessories</i>	<i>Stainless steel steam outlet, flexible hand shower, pipes set into the wall with connections above the ceiling, manual aroma dispenser (Zephyr) or automatic aroma doser (Pro-E / Pro-R)</i>
<i>Audio</i>	<i>Optional</i>
<i>Consumables</i>	<i>Included 0,5l bottle "Stenal Therm Fresh" aroma</i>
<i>Preparations by Others</i>	<i>Screed with drain inside steam bath; water supply, drain and electric connection in the plant room. After installation: waterproofing and tiling</i>
<i>Water supply</i>	<i>Cold water, 2-4 bar, connection 3/4" GAS UNI ISO 228/1</i>
<i>Maintenance</i>	<i>Clean frequent cleaning with a sanitising product (Recommended: Destacryl), steam generator descaling</i>
<i>Norms</i>	<i>CE, on request ETL on select models</i>
<i>Production</i>	<i>Made in Italy</i>

# Configurazioni

# Configurations

Freestanding SX  
Freestanding Left



Freestanding DX  
Freestanding Right



Freestanding Vetrata SX  
Freestanding Glaze Left



Freestanding Vetrata DX  
Freestanding Glaze Right



Incasso SX  
Built-in Left

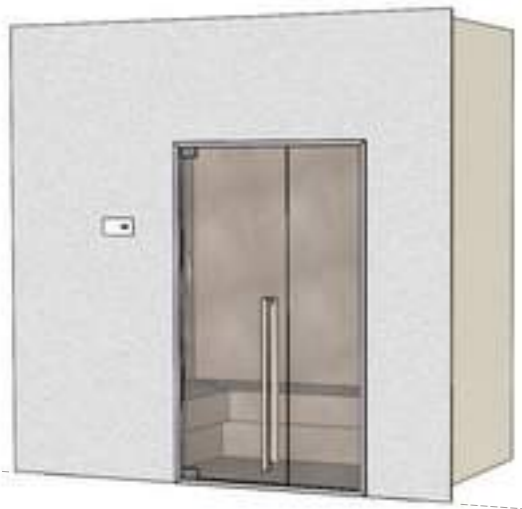

Incasso DX  
Built-in Right

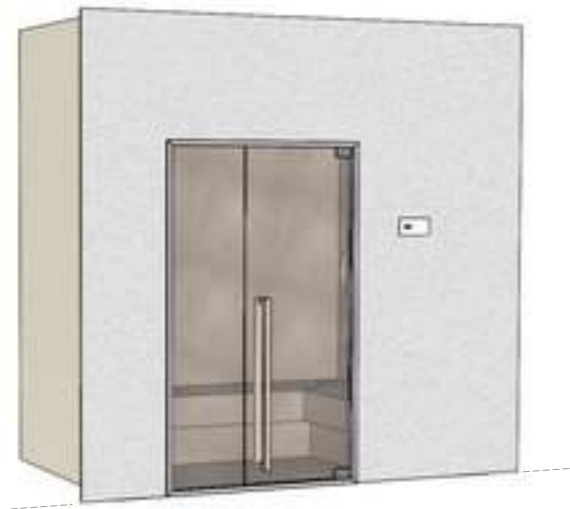

Incasso Vetrata SX  
Built-in Glaze Left

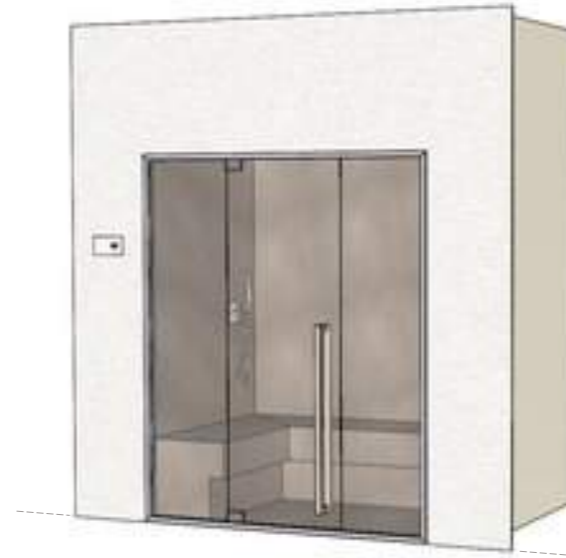

Incasso Vetrata DX  
Built-in Glaze Right

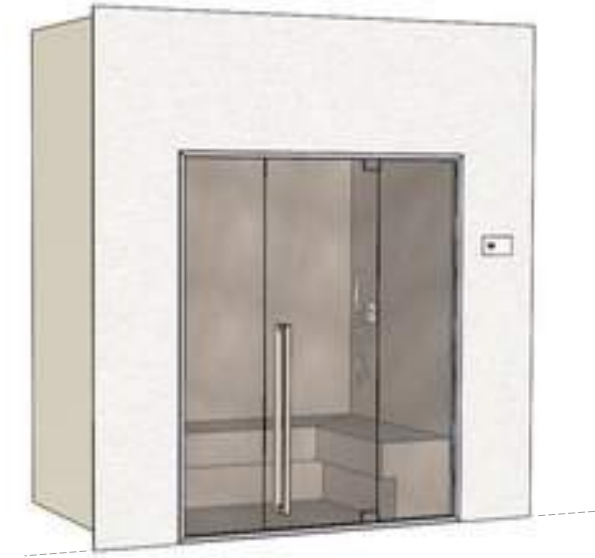

Corner SX  
Corner Left



Corner DX  
Corner Right



Corner Vetrata SX  
Corner Glaze Left



Corner Vetrata DX  
Corner Glaze Right



Taglia S

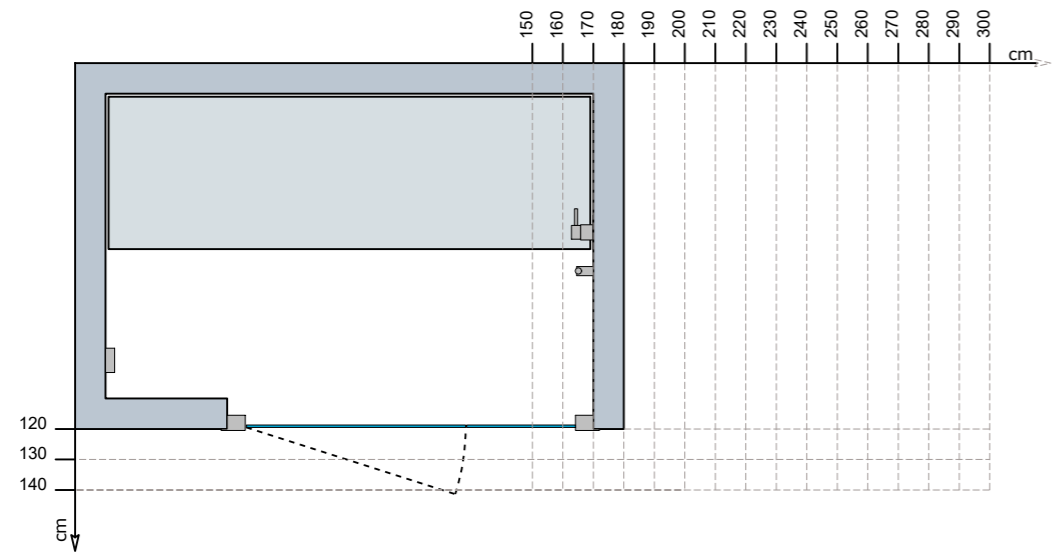

Size S

Taglia S + vetrata

Size S + glaze

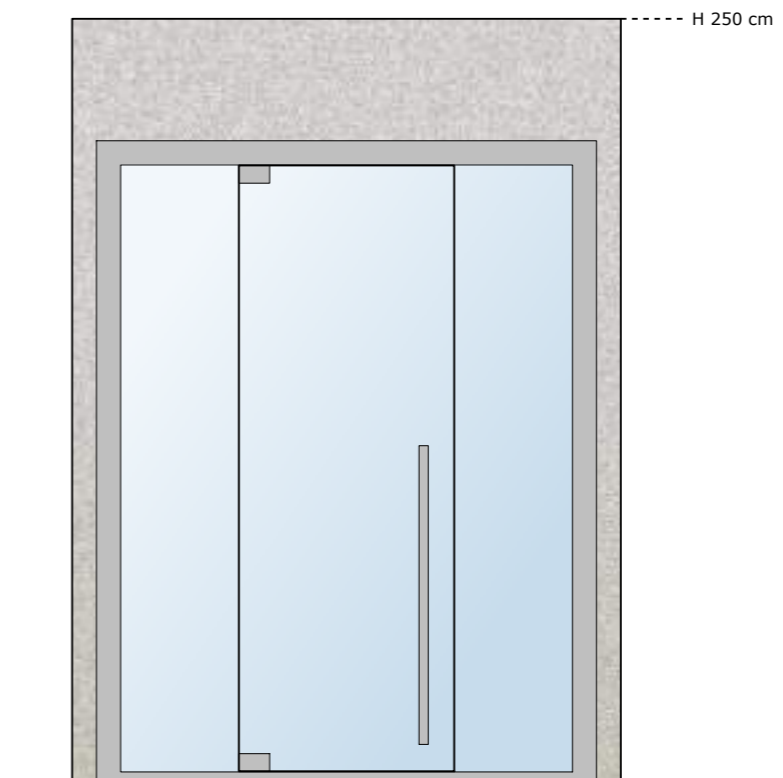
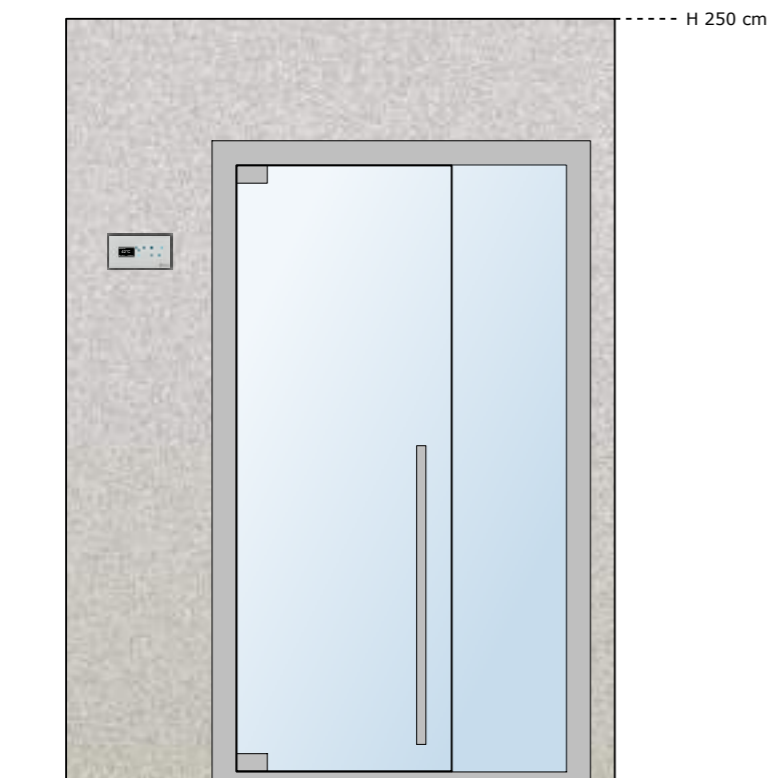
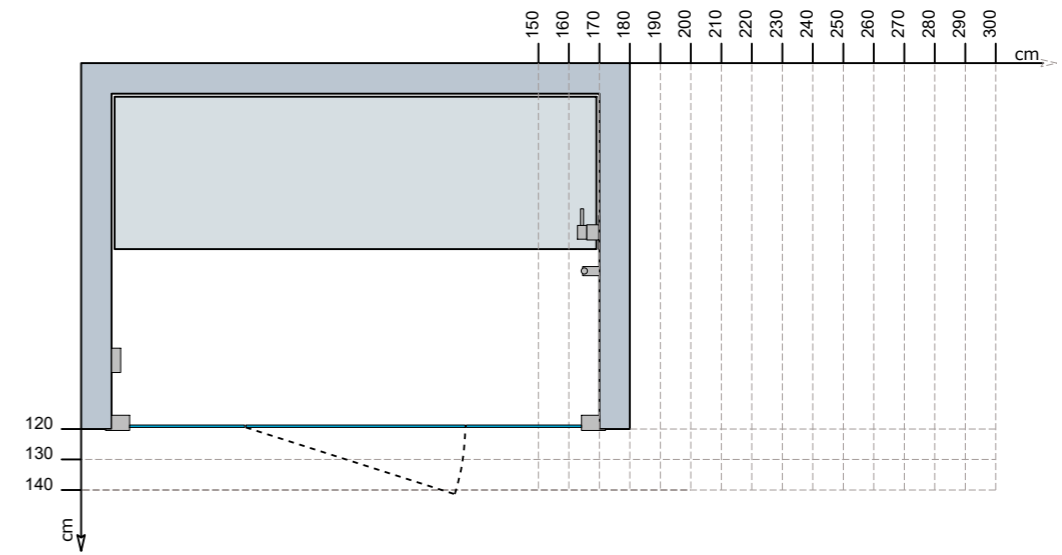

Taglia M

Size M

Taglia M + vetrata

Size M + glaze

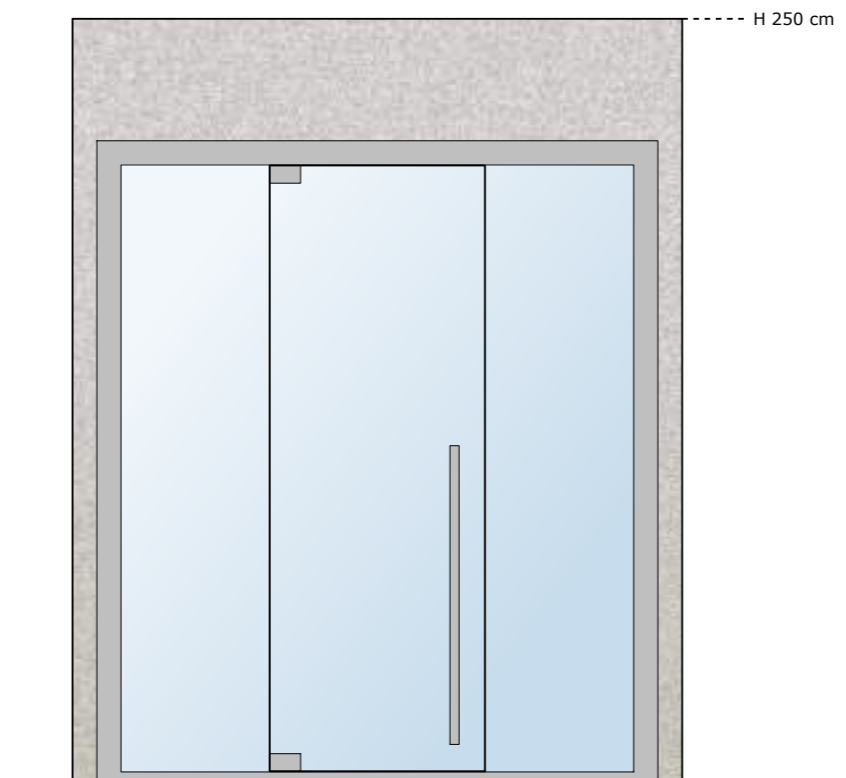
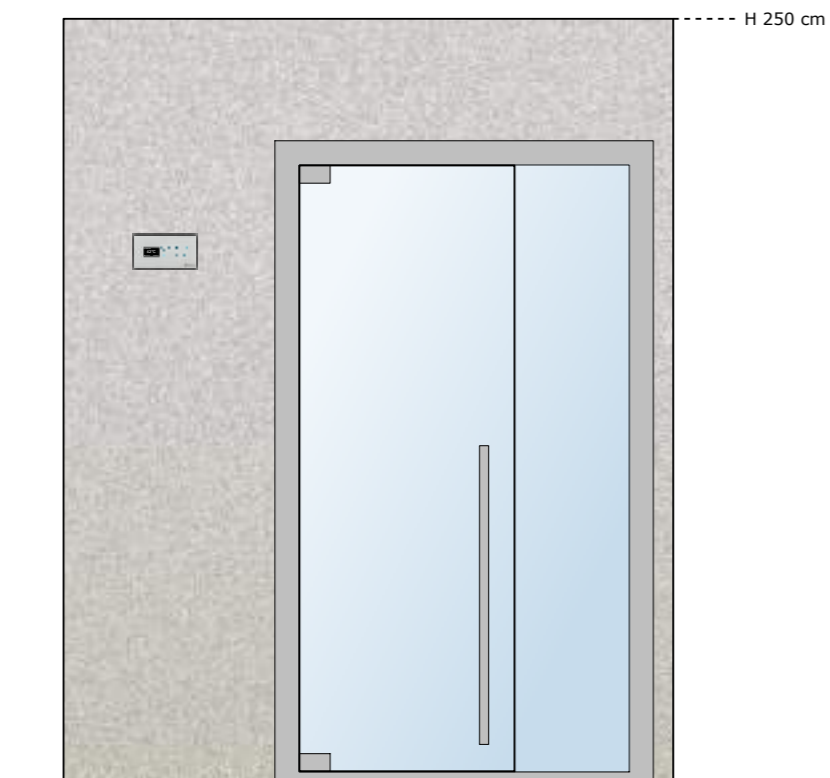
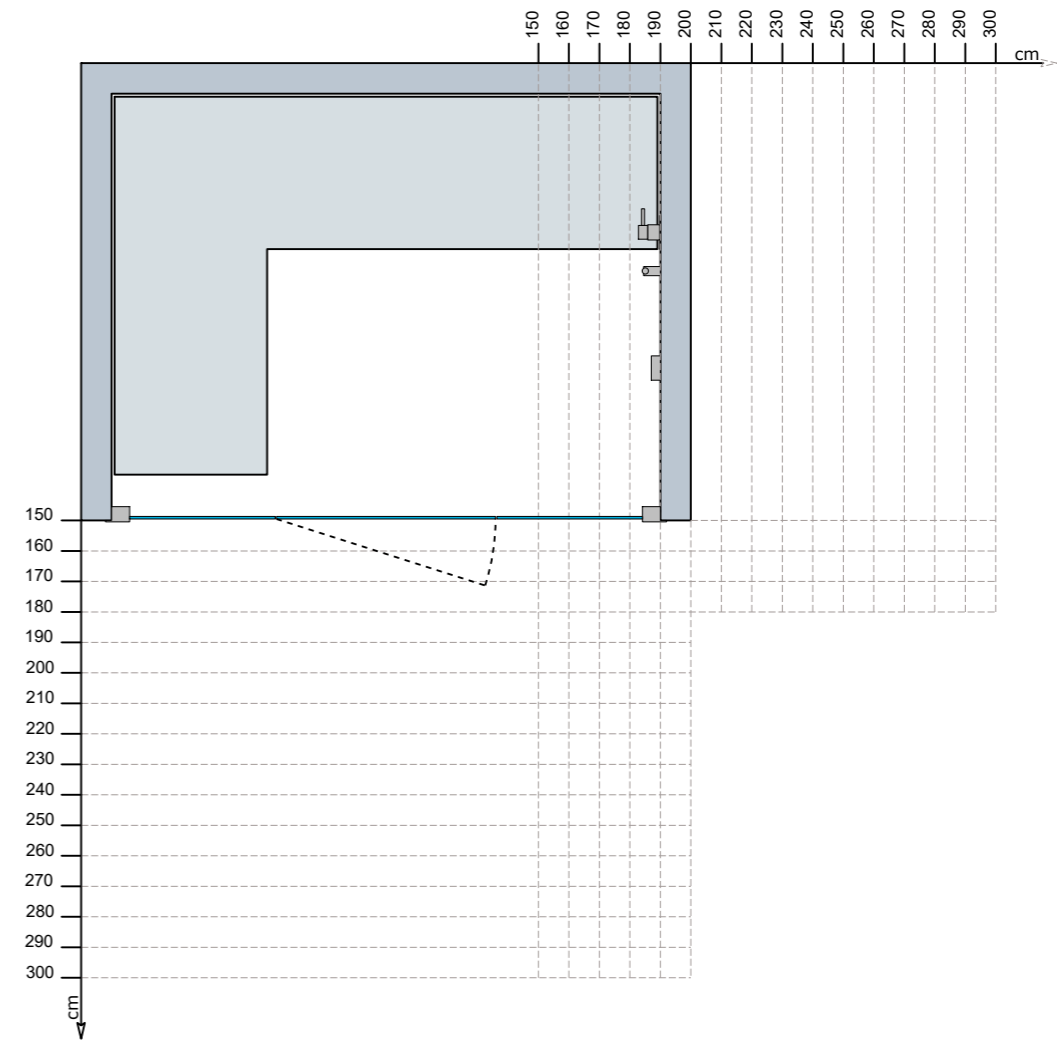
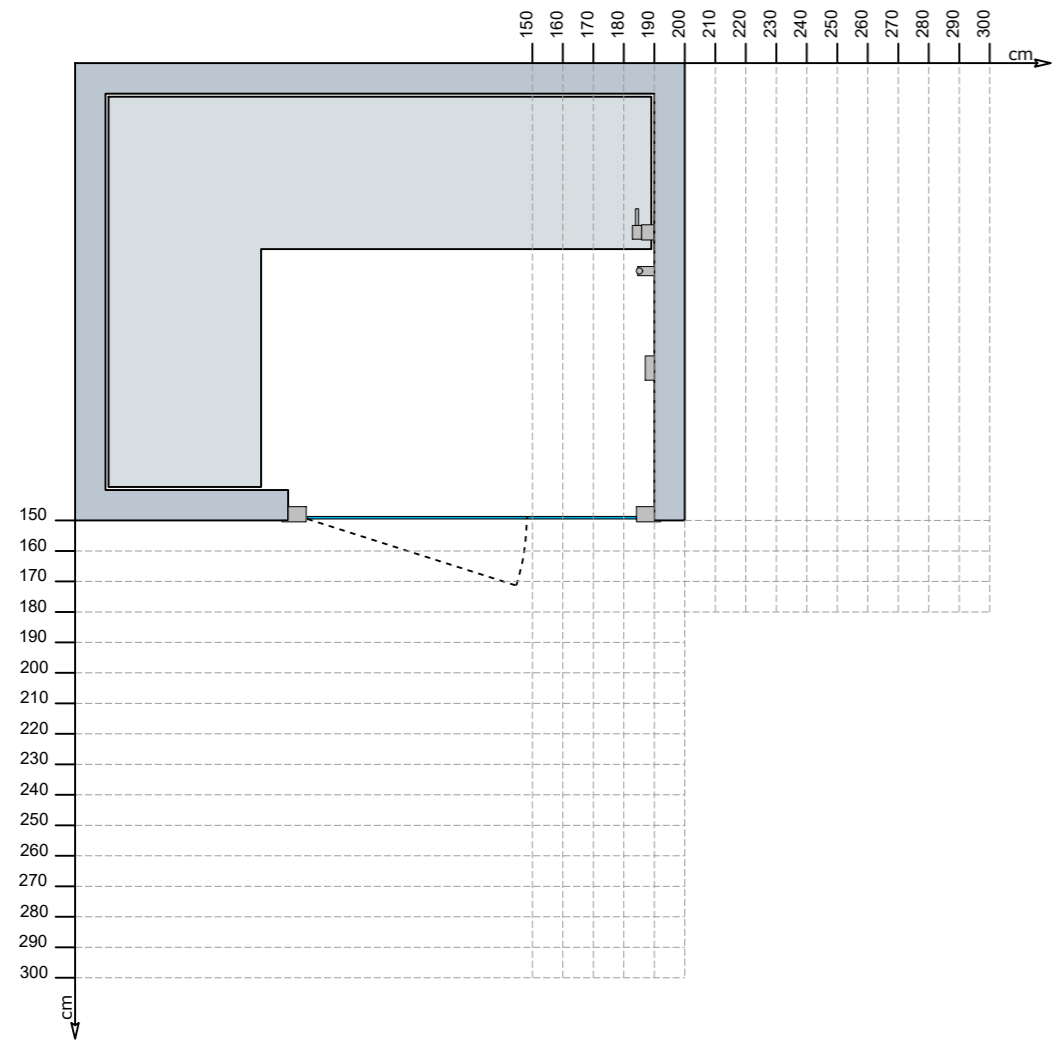

Taglia L

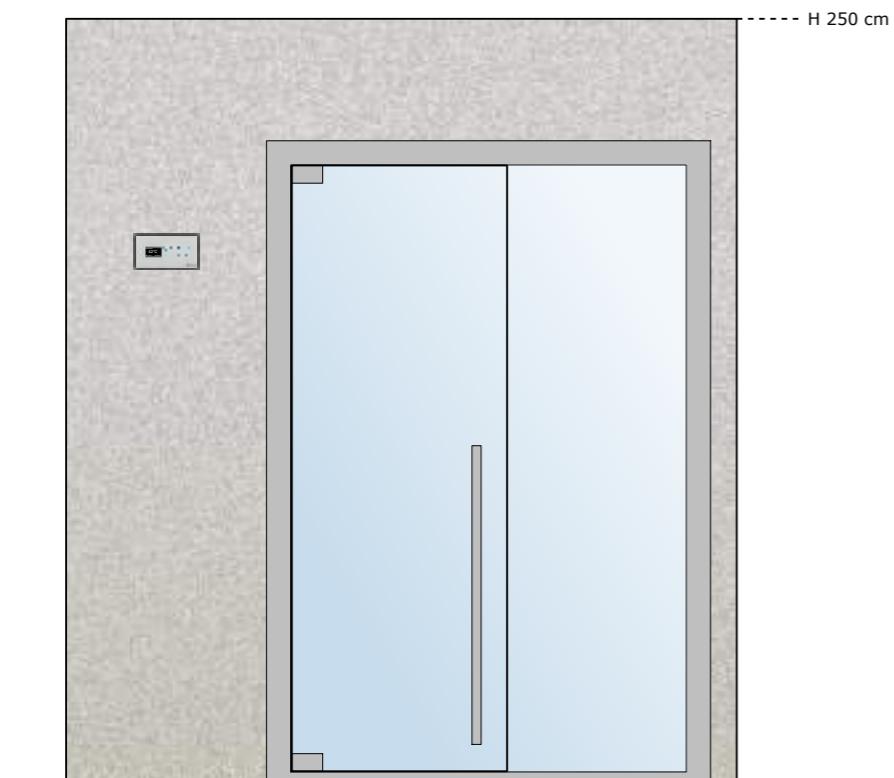
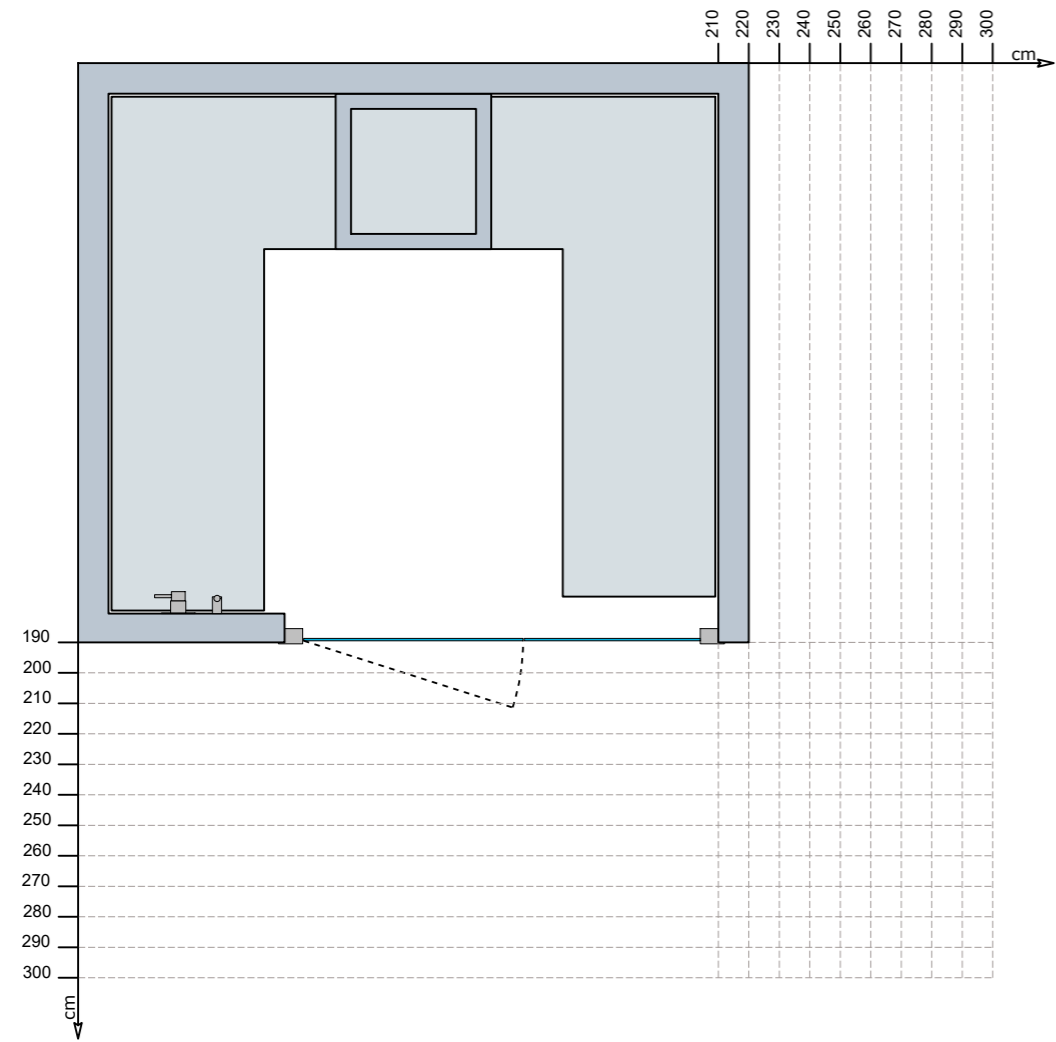

Size L

Taglia L + vetrata

Size L + glaze

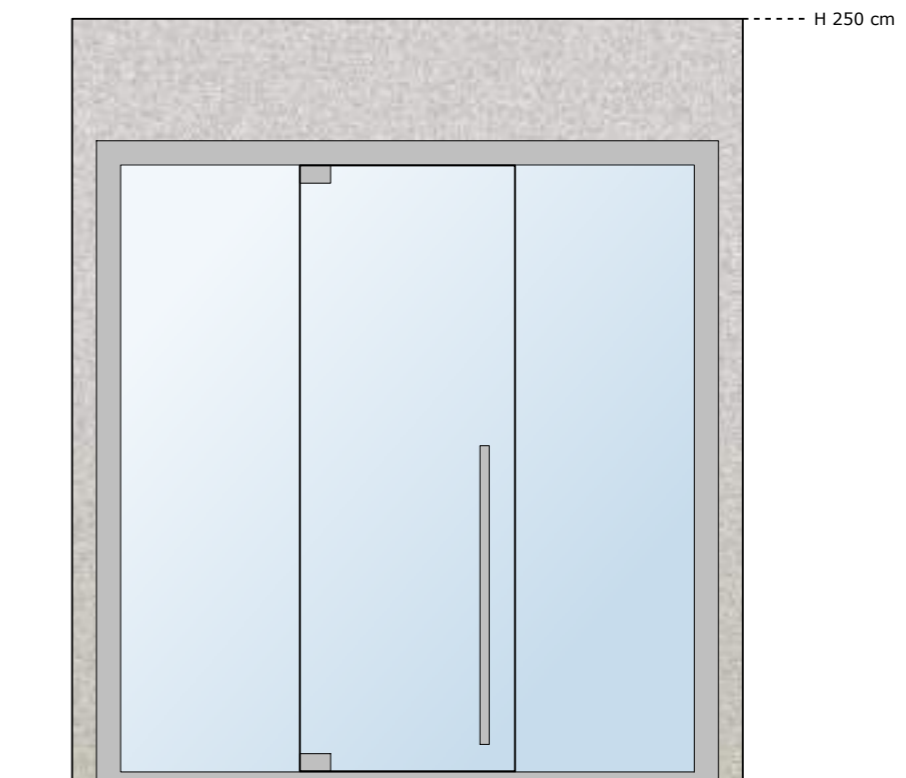
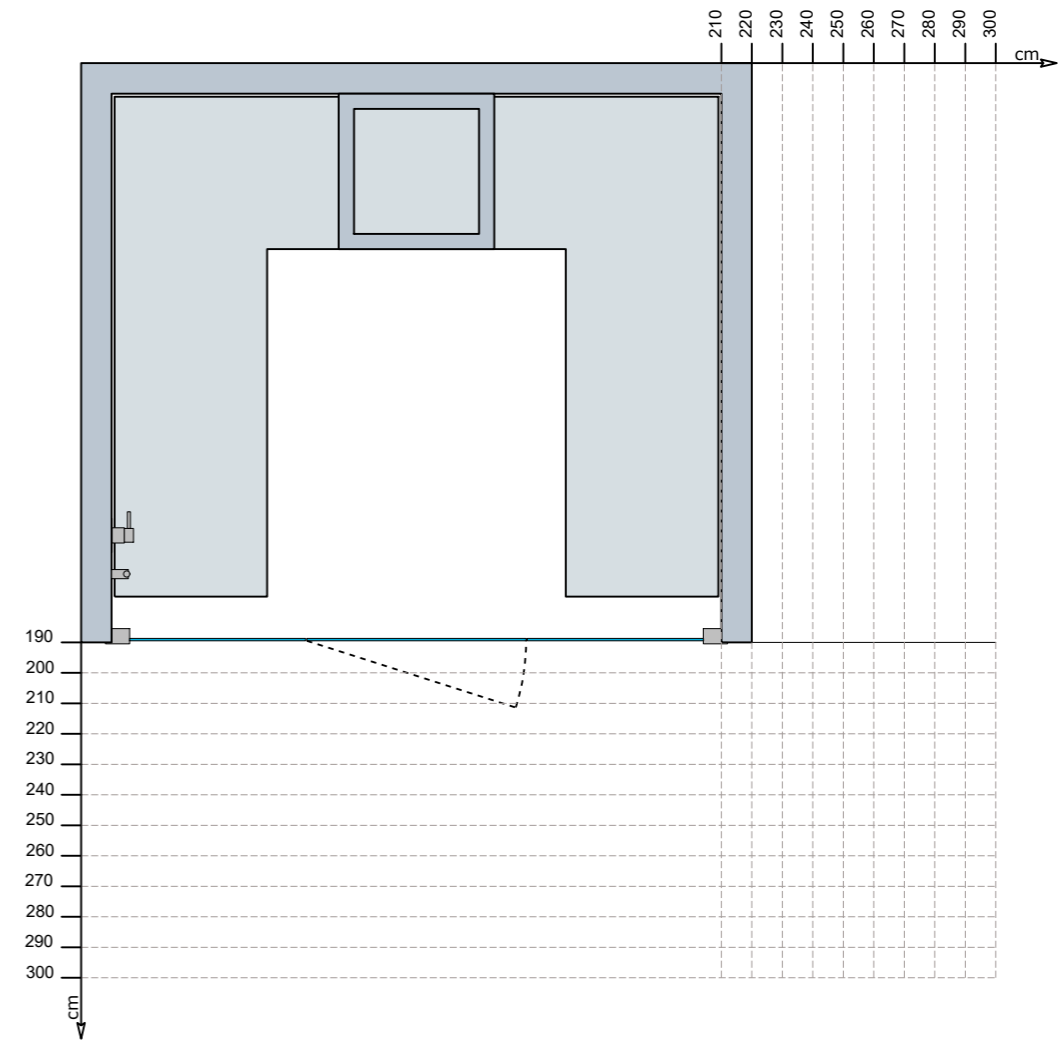

## Funzioni e dotazioni

SteamCustom Domestic SteamCustom Professionale Moon SteamShower

	Centralina Touch	●	○	○	●
	Generatore di vapore Pro-E idoneo per acqua non addolcita	○	●	○	○
	Generatore di vapore Pro-R idoneo per tutti i tipi di acqua	○	○	●	○
	Generatore di vapore Zephyr idoneo per tutti i tipi di acqua	●	-	-	●
	Panche squadrate modello A	●	●	●	○
	Panche riscaldate	○	○	○	○
	Pavimento portante	○	○	○	○
	Stenal AirSystem	○	○	○	-
	1 doccino flessibile	●	●	●	●
	Aroma manuale	●	●	●	●
	Aroma automatico	○	●	●	○
	Aromarium 4 essenze	○	○	○	○
	Casse audio	○	○	○	○
	Bluetooth	○	○	○	○
	Illuminazione perimetrale bianco caldo	○	○	○	○
	Cielo stellato illuminazione RGB	○	○	○	○
	Luce dietro schienale bianco caldo	○	○	●	○
	Luce sotto panca bianco caldo	●	●	●	○
	Cascata di fibre ottiche	○	○	○	○
	Pulsante di chiamata	○	○	○	○
	Pulsante di arresto	○	○	○	○
	SmartSpa System Interfaccia Alexa / Google Home	○	○	○	○

● Incluso di serie ○ Optional - Non compatibile

## Functions and features

SteamCustom Home SteamCustom Commercial Moon SteamShower

	Control unit Touch	●	○	○	●
	Pro-E Steam Generator suitable for non-softened water	○	●	○	○
	Pro-R Steam Generator suitable for all kinds of water	○	○	●	○
	Zephyr Steam Generator suitable for all kinds of water	●	-	-	●
	Square benches, model A	●	●	●	○
	Heated benches	○	○	○	○
	Floor	○	○	○	○
	Stenal AirSystem	○	○	○	-
	1 flexible hand shower	●	●	●	●
	Manual aroma dosing	●	●	●	●
	Automatic aroma dosing	○	●	●	○
	Aromarium 4 aromas	○	○	○	○
	Loudspeakers	○	○	○	○
	Bluetooth	○	○	○	○
	Warm white perimeter lighting	○	○	○	○
	Starry sky RGB lighting	○	○	○	○
	Warm white light behind the backrest	○	○	●	○
	Warm white light below the bench	●	●	●	○
	Fibre optics feature light	○	○	○	○
	Call button	○	○	○	○
	Stop button	○	○	○	○
	SmartSpa System Alexa / Google Home interface	○	○	○	○

● Included ○ Optional - Not available

**Illuminazione perimetrale a soffitto**

In un ambiente dedicato al perfetto relax di corpo e mente la luce gioca un ruolo fondamentale: i punti luce bianco caldo disposti a soffitto lungo il perimetro del bagno turco illuminano e scaldano lo spazio con eleganza e accentuano il prestigio dei materiali.



**Ceiling perimeter lighting**

*In an environment devoted to body and mind relaxation, light plays an essential role: warm white spots of light along the perimeter of the ceiling bring light, warmth and style to the steam room and emphasise the quality of the materials.*

**Cielo stellato con CromoLux**

La disposizione a soffitto di una miriade di puntini luminosi che passano delicatamente da un colore all'altro crea inediti effetti di luce e atmosfere personalizzabili grazie alla possibilità di fermo colore. La speciale tecnologia a fibre ottiche garantisce un sistema estremamente silenzioso, assicurando un'atmosfera suggestiva e rilassante.



**Starry sky with CromoLux**

*Multiple tiny colour-changing spots of light fitted in the ceiling to create unique light effects, with the option to control the colour settings and personalise the mood. The special fibre optics technology guarantees an extremely quiet lighting system, ensuring a striking atmosphere and a relaxing experience.*

**Schienale retroilluminato**

Una luce continua e omogenea dietro lo schienale della panca superiore proietta verso l'alto un'illuminazione soffusa e indiretta, che gioca con la texture dei materiali ed enfatizza la tridimensionalità dei volumi.



**Backrest strip lighting**

*A constant and homogeneous light behind the bench backrest projects a soft, indirect light on the ceiling emphasising the texture of the materials and three-dimensional shapes.*

**Illuminazione sottopanca**

L'illuminazione rivolta verso il basso dona un effetto scenografico e accattivante. La luce indiretta mantiene l'atmosfera di quieta intimità dell'ambiente.

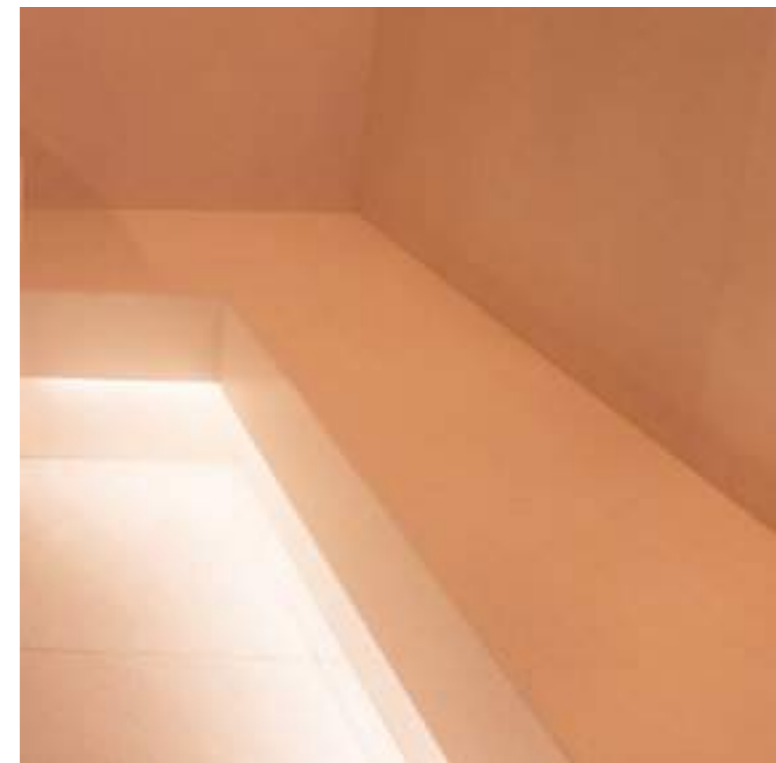

**Under-bench lighting**

*The down-facing lights create an evocative and suggestive effect. The indirect light endows the steam room with quiet intimacy.*



**Centralina remotabile Touch (optional)**

Centralina **100% Made in Italy**. La perfetta combinazione di design e tecnologia. Compatibilità con accensione domotica. Misure cm 20x10.

**Touch control unit (optional)**

Control unit **100% Made in Italy**. Combines high end design and cutting edge technology. Compatible with home automation systems. Size: 20x10 cm.

**Erogazione del vapore**

Ogni dettaglio fa di un bagno turco Stenal un ambiente unico e inimitabile dove nulla è lasciato al caso e ogni accessorio è disegnato per coniugare stile e funzionalità. Come la bocchetta per l'uscita del vapore, in acciaio lucidato, che incorpora la migliore tecnologia lasciando in vista solo linee pulite ed essenziali.

**Steam outlet**

Every detail of a Stenal steam bath contributes to making it a unique and inimitable experience. Nothing is left to chance, each feature has been designed to offer style and functionality. The polished steel steam outlet, which contains state of the art technology, leaves in view only clean essential lines.

**Doccino flessibile**

Tutti i bagni turchi Stenal includono almeno un doccino flessibile con miscelatore di acqua calda e fredda, per risciacquare le panche prima di sedersi e rinfrescarsi di tanto in tanto.

**Flexible shower hose**

All Stenal steam rooms include at least one flexible shower hose with warm and cold water mixer, to rinse the benches and refresh the skin every now and then.

**Casse audio**

Speciali casse audio per bagno turco collegabili a impianto di filodiffusione esterno.

**Loudspeakers**

Special steamproof loudspeakers which can be connected to an external audio source.

**Bluetooth**

Ricevitore bluetooth per controllare la musica direttamente dal tuo smartphone.

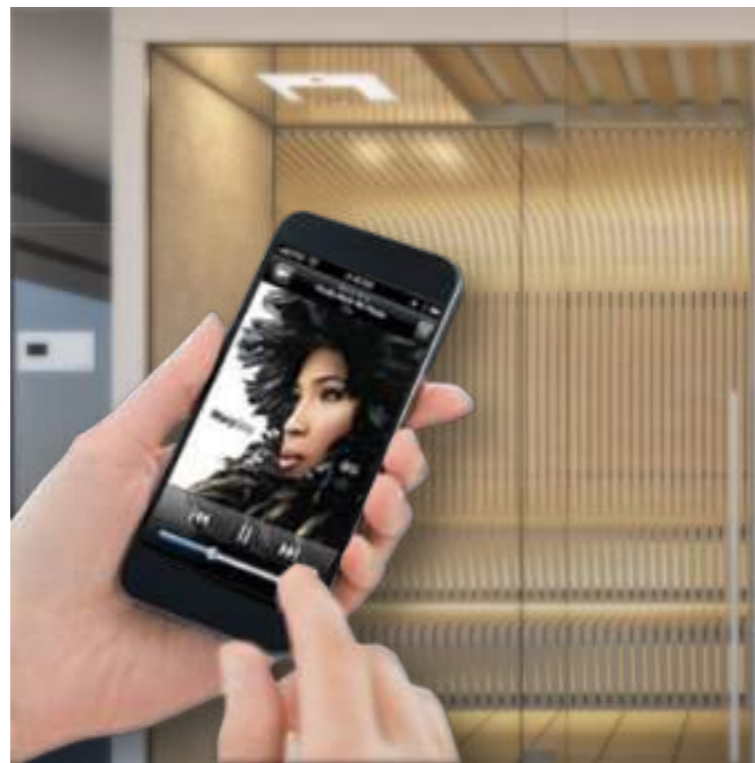
**Bluetooth**

Bluetooth receiver, to control music from your smartphone.

**Cubotto vapore**

L'elegante cubotto vapore permette di far uscire il vapore in un elemento d'arredo che impedisce il contatto accidentale, rendendo il bagno turco più sicuro da utilizzare.

**Steam cube**

The steam cube allows steam to form inside a decorative element, preventing accidental contact and making for a safer steam room.

**Aromarium**

Impianto di aromatizzazione a 4 aromi. Il cliente finale potrà selezionare l'aroma desiderato tramite una tastiera all'interno del bagno turco.

**Aromarium**

Aroma dosing system with 4 aromas. The end user can select an aroma using a keypad inside the steam room.

**Stenal AirSystem**

Sistema di ricambio aria, con miscelazione aria fresca al vapore ed estrazione aria esausta. Consigliato per bagni turchi ad uso intensivo. Vantaggi: distribuzione omogenea del vapore da pavimento a soffitto, ricambio continuo dell'aria in cabina, asciugatura rapida a fine utilizzo.

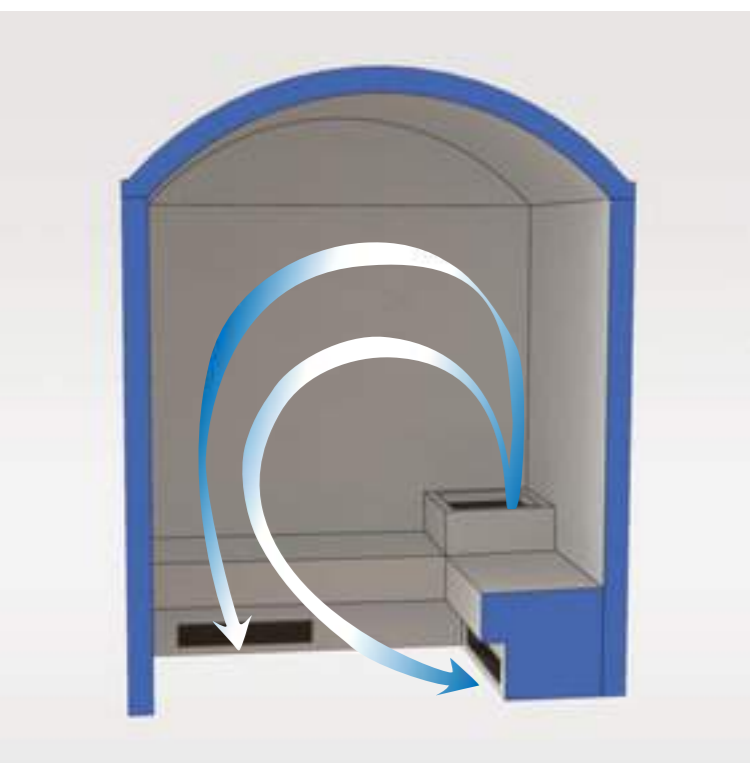
**Stenal AirSystem**

*Air exchange system that mixes fresh air with steam and extracts exhaust air. Recommended for steam baths subject to intensive use. Advantages: consistent distribution of steam from the floor to the ceiling, constant air exchange in the cabin, quicker drying after use.*

**Panche riscaldate**

Panche riscaldate elettricamente in bassa tensione con speciali resistenze elettriche al carbonio, che garantiscono le prestazioni migliori e lunga durata nel tempo.

**Heated benches**

*Heated benches with special low voltage carbon heating elements, that guarantee maximum performance and long durability.*

**Pulsante di chiamata**

Pulsante di chiamata, da collegare ad un impianto di gestione allarmi o ad una suoneria esterna (non fornita).

**Call button**

*Call button, suitable for high temperatures and humidity. To be connected to an external alarm management system (not supplied).*

**Pulsante di arresto**

Pulsante di arresto, permette di fermare la produzione di vapore quando premuto. Va riarmato manualmente sul posto. Può anche essere collegato ad una suoneria esterna (non fornita).

**Stop button**

*Stops steam production when pressed. Needs to be rearmed locally. Can also be connected to an external buzzer (not supplied).*



A



B



C



D



Panche



Benches



Cascata di fibre ottiche



Fibre optics feature light

Suggestivo effetto "cascata di luce" con possibilità di cambio colore RGB.

Striking fibre optics feature light, with possibility of RGB colour change.

E

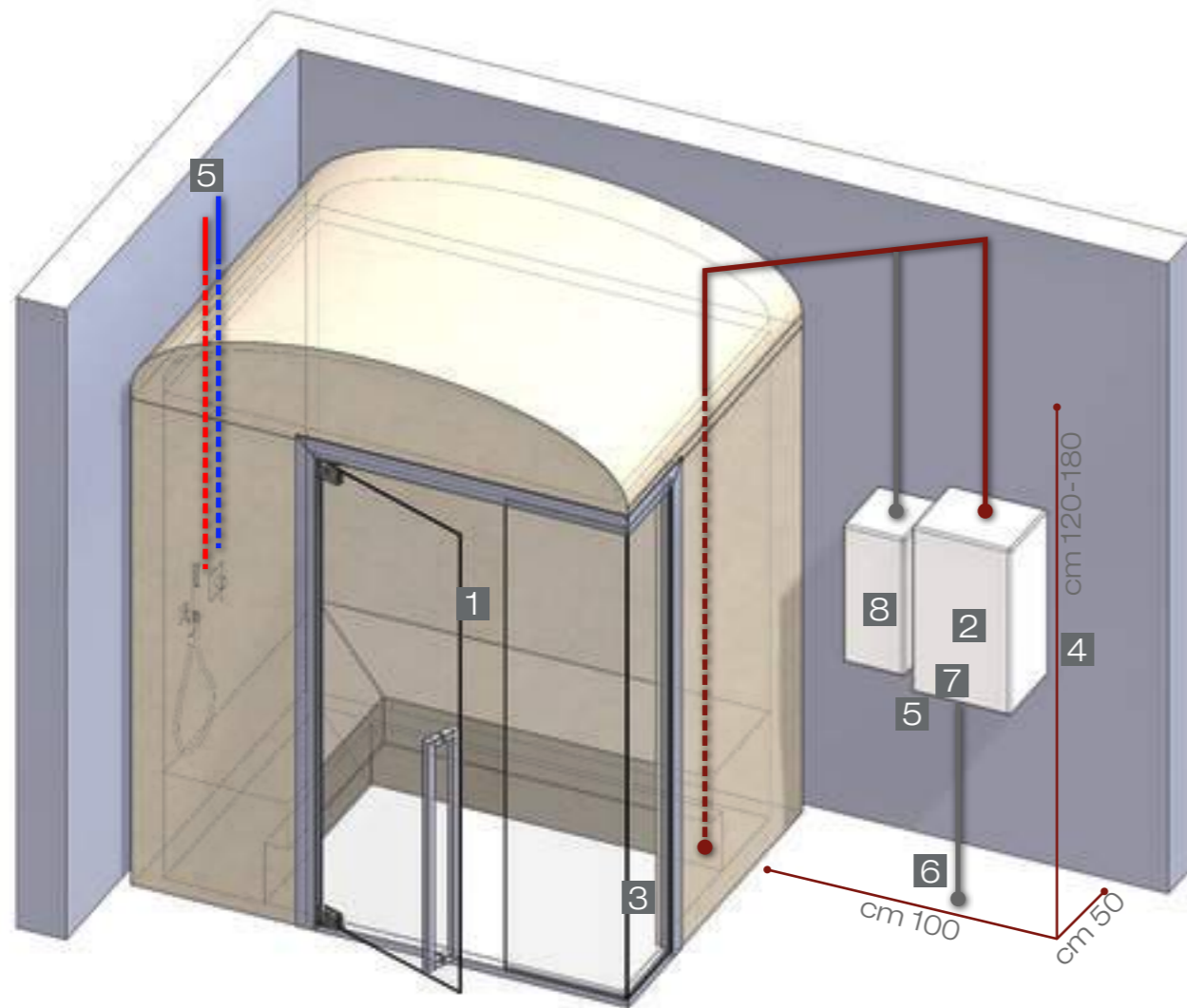

- 1** Cabina bagno turco  
*Steam bath cabin*
- 2** Generatore di vapore  
*Steam generator*
- 3** Uscita vapore  
*Steam outlet*
- 4** Alimentazione elettrica  
*Power supply*
- 5** Collegamento acqua  
*Water supply*
- 6** Scarico  
*Drain*
- 7** Comandi  
*Controls*
- 8** Dosatore di essenze  
*Aroma doser*

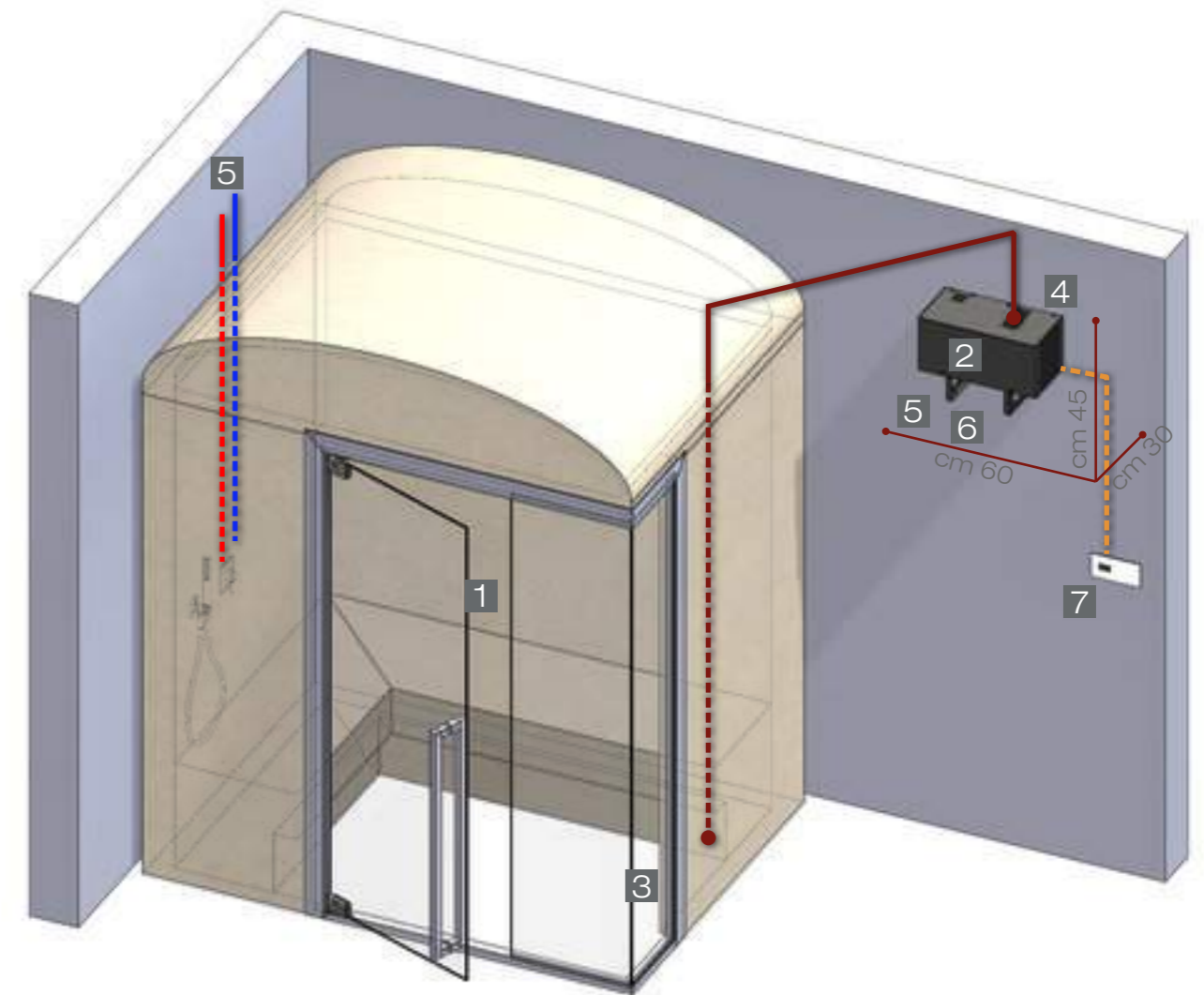

- 1** Cabina bagno turco  
*Steam bath cabin*
- 2** Generatore di vapore Zephyr  
*Zephyr steam generator*
- 3** Uscita vapore  
*Steam outlet*
- 4** Alimentazione elettrica  
*Power supply*
- 5** Collegamento acqua  
*Water supply*
- 6** Scarico  
*Drain*
- 7** Comandi  
*Controls*

# Moon

La soluzione pronta all'uso

*The ready-made steam solution*









**XS**

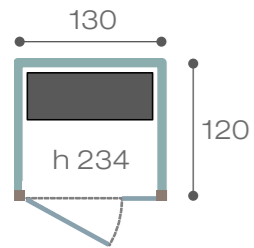

2x 3,0 kW / 230V

**S**

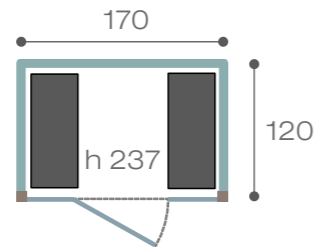

2x 3,0 kW / 230V

**M**

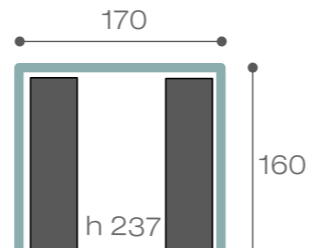

4x 6,0 kW / 230V  
6,0 kW / 400V  
2x

**L**

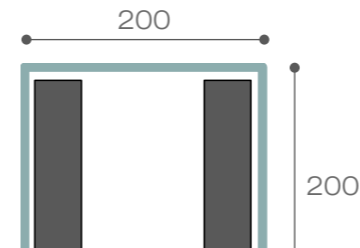

6x 6,00 kW / 230V  
6,00 kW / 400V  
2x

**Pro**

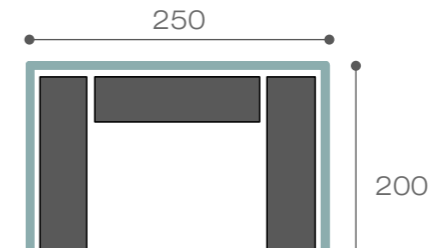

7x 9,0 kW / 400V  
2x

**Maxi**

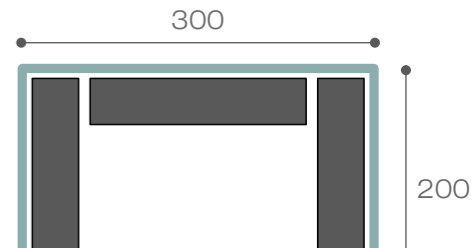

9x 9,0 kW / 400V  
3x

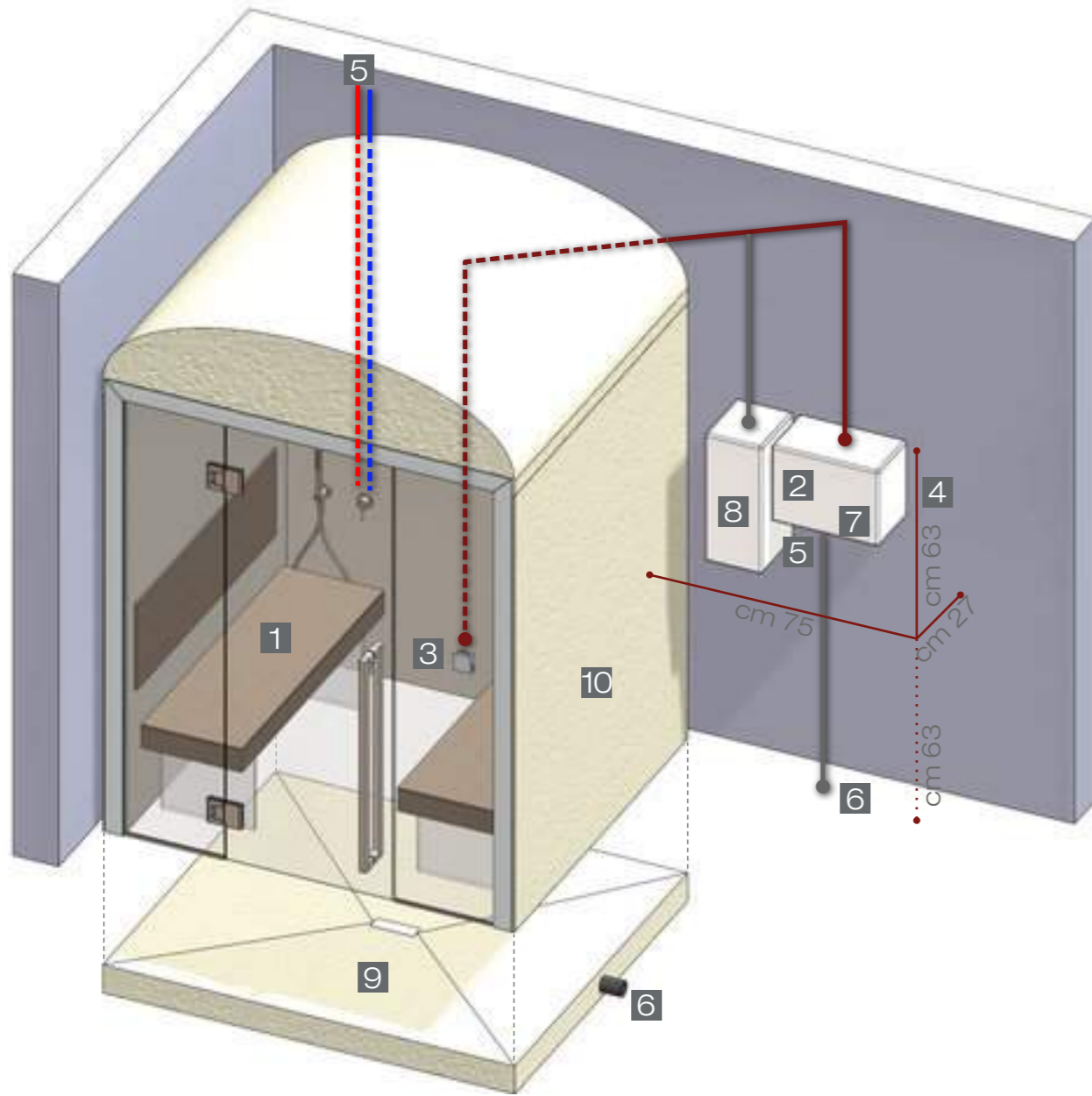

- |   |  |
|---|--|
| <b>1</b> Cabina bagno turco<br><i>Steam bath cabin</i>  | <b>6</b> Scarico<br><i>Drain</i>   |
| <b>2</b> Generatore di vapore<br><i>Steam generator</i> | <b>7</b> Comandi<br><i>Controls</i>  |
| <b>3</b> Uscita vapore<br><i>Steam outlet</i>           | <b>8</b> Dosatore di essenze<br><i>Aroma dosing system</i>   |
| <b>4</b> Alimentazione elettrica<br><i>Power supply</i> | <b>9</b> Pavimento opzionale con scarico,<br>spessore regolabile 16-20 cm<br><i>Optional floor with drain,<br/>adjustable thickness 16-20 cm</i> |
| <b>5</b> Collegamento acqua<br><i>Water supply</i>      | <b>10</b> Esterno predisposto per<br>rivestimento in pannelli<br><i>Externally prepared for a panelling<br/>finish</i>                           |

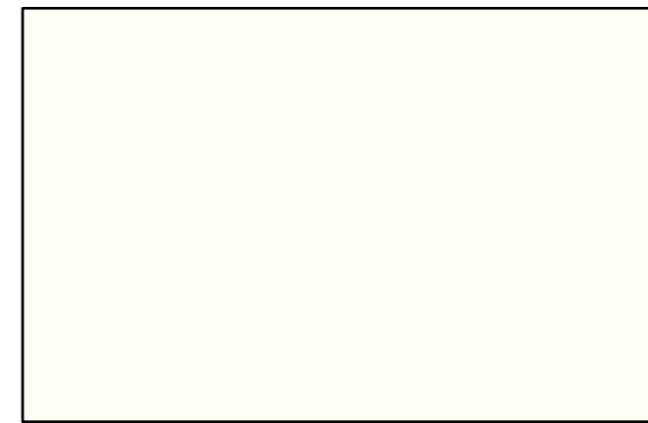

Materiale: GRP      *Material: GRP*  
 Colore: RAL 9016      *Colour: RAL 9016*  
 Finitura: Lucida      *Finish: Glossy*

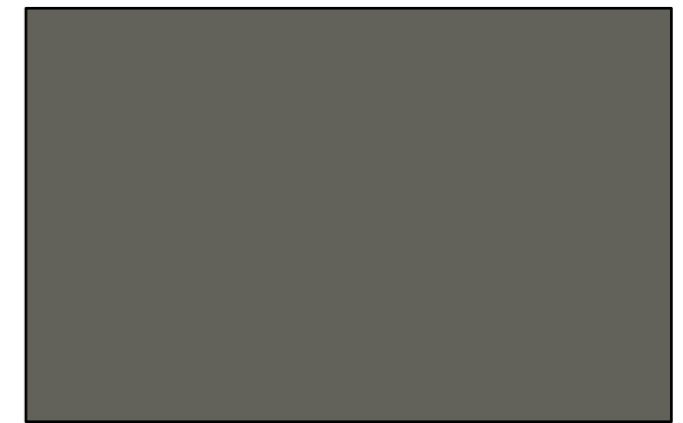

Materiale: GRP      *Material: GRP*  
 Colore: RAL 7039      *Colour: RAL 7039*  
 Finitura: Lucida      *Finish: Glossy*

Panche

Benches



Materiale: ceramica      *Material: ceramic*  
 Colore: Black Marquinia      *Colour: Black Marquinia*  
 Finitura: Satin      *Finish: Satin*



Materiale: ceramica      *Material: ceramic*  
 Colore: Onice Avorio      *Colour: Ivory Onyx*  
 Finitura: Satin      *Finish: Satin*

Illuminazione

Lighting



Tipo: Led lineari      *Type: Linear led*  
 Colore: 2700°K      *Colour: 2700°K*



Tipo: Cielo stellato      *Type: Starry sky*  
 Colore: RGB      *Colour: RGB*

## Scheda tecnica: bagno turco Moon

Funzioni	Bagno turco
Temperatura	40-45°C
Umidità relativa	98-100%
Sistema di riscaldamento	Generatore di vapore
Sistema di controllo	Tastiera esterna
Tensione elettrica	Standard 400V, su richiesta 230V fino a 6 kW
Potenza elettrica	A seconda delle dimensioni
Materiale pareti	GRP rinforzato, rivestito internamente con gelcoat lucido. Esternamente da rivestire; predisposto per un rivestimento in pannelli (ad es. cartongesso marino)
Spessore pareti	60 mm
Pavimento	Struttura priva di pavimento, da incollare su un pavimento finito piastrellato. Optional pavimento spessore 16-20 cm (con piedini regolabili) con piletta raccordata su un lato a scelta
Porta	In cristallo temperato con telaio in alluminio. Luce netta di passaggio cm 70x199. Spessore: 8mm
Forma delle panche	Squadrata, con zampe trasparenti
Materiale delle panche	Ceramica
Illuminazione	Strip-led bianco caldo 2700°K, sotto panca e dietro lo schienale
Accessori in dotazione	Bocchetta uscita vapore in acciaio inox, doccia flessibile, incasso tubi a parete con raccordo sopra il soffitto, aroma automatico
Audio	Optional
Prodotti di consumo	Inclusa essenza Stenal Therm Fresh 0,5l
A cura del cliente	Pavimento piastrellato con piletta di scarico all'interno del bagno turco; allacciamento acqua, scarico e allacciamento elettrico nel vano tecnico. La cabina è finita e non richiede impermeabilizzazioni e rivestimenti.
Allacciamento acqua	Acqua fredda, 2-4 bar, attacchi da 3/4" GAS UNI ISO 228/1
Manutenzioni periodiche	Pulizia frequente con prodotto igienizzante (consigliato: Destacryl), svuotamento calcare
Normativa	CE; su richiesta ETL per alcuni modelli
Produzione	Made in Italy

## Datasheet: steam room Moon

Features	Steam bath
Temperature	40-45°C
Humidity	98-100%
Heating system	Steam generator
Control system	External control
Voltage	Standard 400V, 230V up to 6 kW on request
Electric power	Depending on size
Walls material	Reinforced GRP, coated internally with a gelcoat layer, glossy finish. Externally the walls are prepared for application of a panelling finish (i.e. water-resistant drywall)
Wall thickness	60 mm
Floor	The structure has no floor and will be glued to an existing finished tiled floor. Optional floor, 16-20 cm thick (adjustable on leveling feet), with drain linked to the side
Door	Tempered glass with aluminium frame. Door clearance: cm 70x199. Thickness: 8mm
Benches shape	Regular, with transparent legs
Benches material	Ceramic
Lighting	Warm white 2700°K linear led below the bench and behind the backrest
Included accessories	Stainless steel steam outlet, flexible hand shower, pipes set into the wall with connections above the ceiling, automatic aroma doser
Audio	Optional
Consumables	Included 0,5l bottle "Stenal Therm Fresh" aroma
Preparations by Others	Tiled floor with drain inside steam bath; water supply, drain and electric connection in the plant room. The cabin is finished and does not require waterproofing and tiling.
Water supply	Cold water, 2-4 bar, connections 3/4" GAS UNI ISO 228/1
Maintenance	Clean frequent cleaning with a sanitising product (Recommended: Destacryl), steam generator descaling
Norms	CE, on request ETL on select models
Production	Made in Italy

# SteamShower

## Doccia vapore

**SteamShower** permette di concedersi un bagno di vapore anche dove c'è poco spazio. Ideale per un bagno privato, per la suite alberghiera e per le cabine estetica.

Disponibile in tre varianti:

- Bianco, colore RAL 9016, lucido
- Tortora, colore RAL 7039, lucido
- Piastrellabile (piastrelle non incluse)

*SteamShower* enables the user to enjoy a steam bath even where space is at a premium. Ideal for private homes, for hotel suites and for treatment rooms.

Available in three options:

- White, colour RAL 9016, glossy
- Dove grey, colour RAL 7039, glossy
- Rough body, to be tiled (tiles not included).

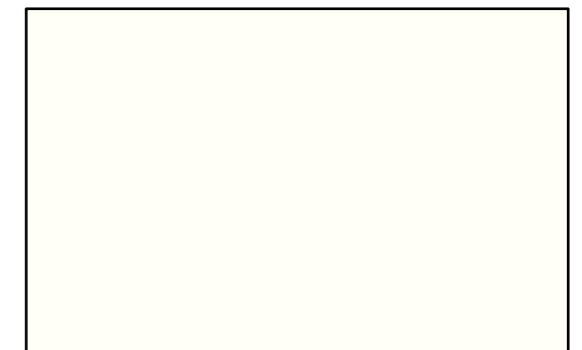

RAL 9016

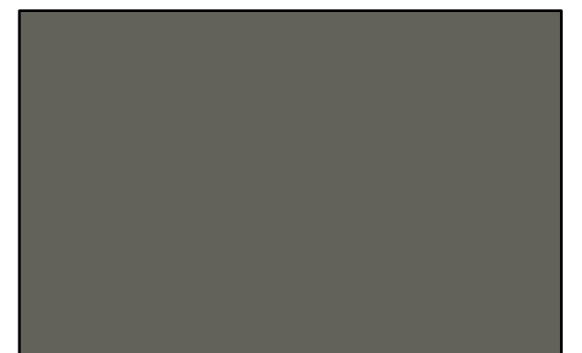

RAL 7039

## SteamShower L

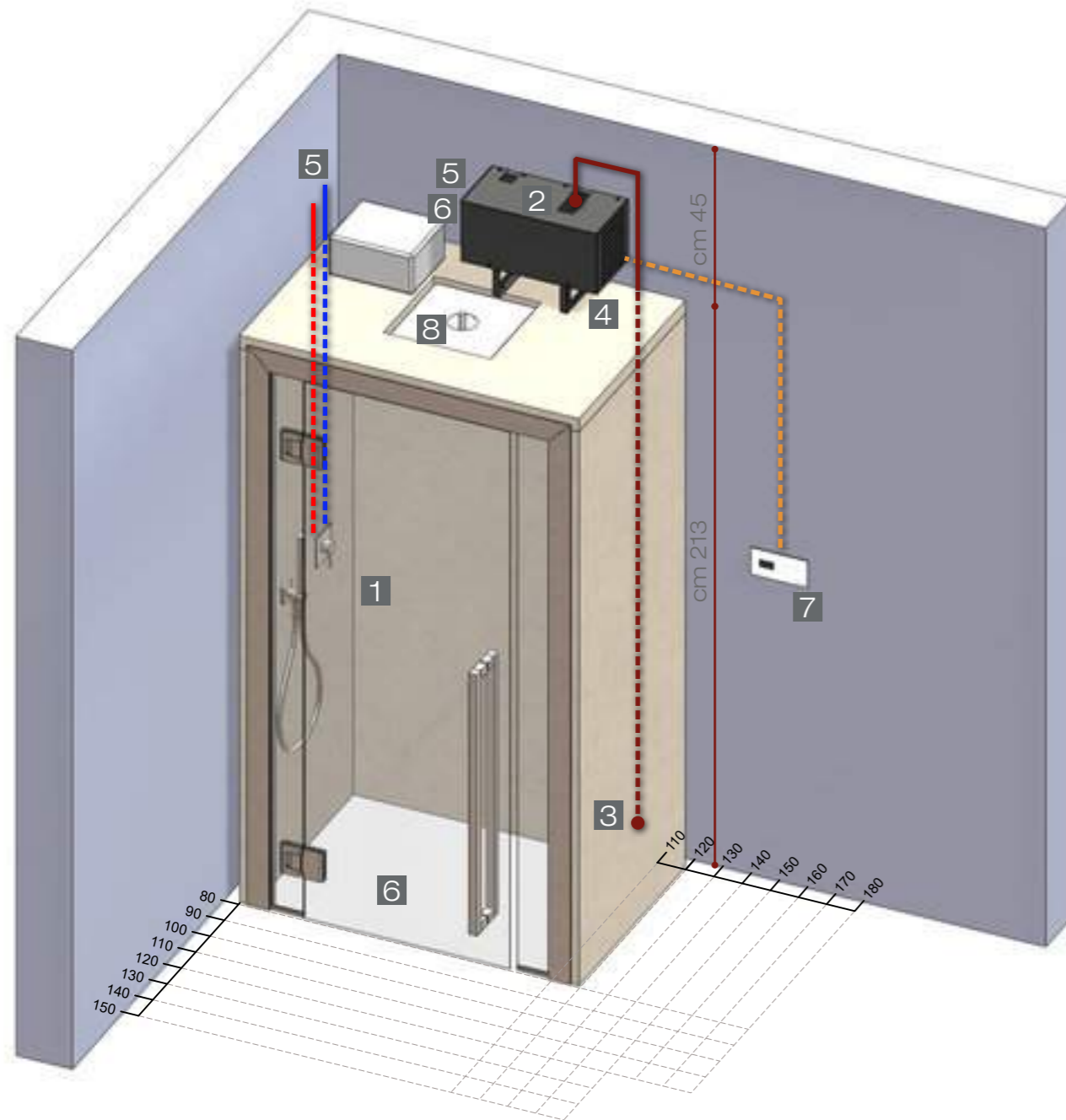

- 1** SteamShower  
*SteamShower*
- 2** Generatore di vapore  
*Steam generator*
- 3** Uscita vapore  
*Steam outlet*
- 4** Alimentazione elettrica  
*Power supply*
- 5** Collegamento acqua  
*Water supply*
- 6** Scarico  
*Drain*
- 7** Comandi vapore + luce  
*Steam + light controls*
- 8** Soffione doccia  
*Shower head*

## SteamShower L Corner

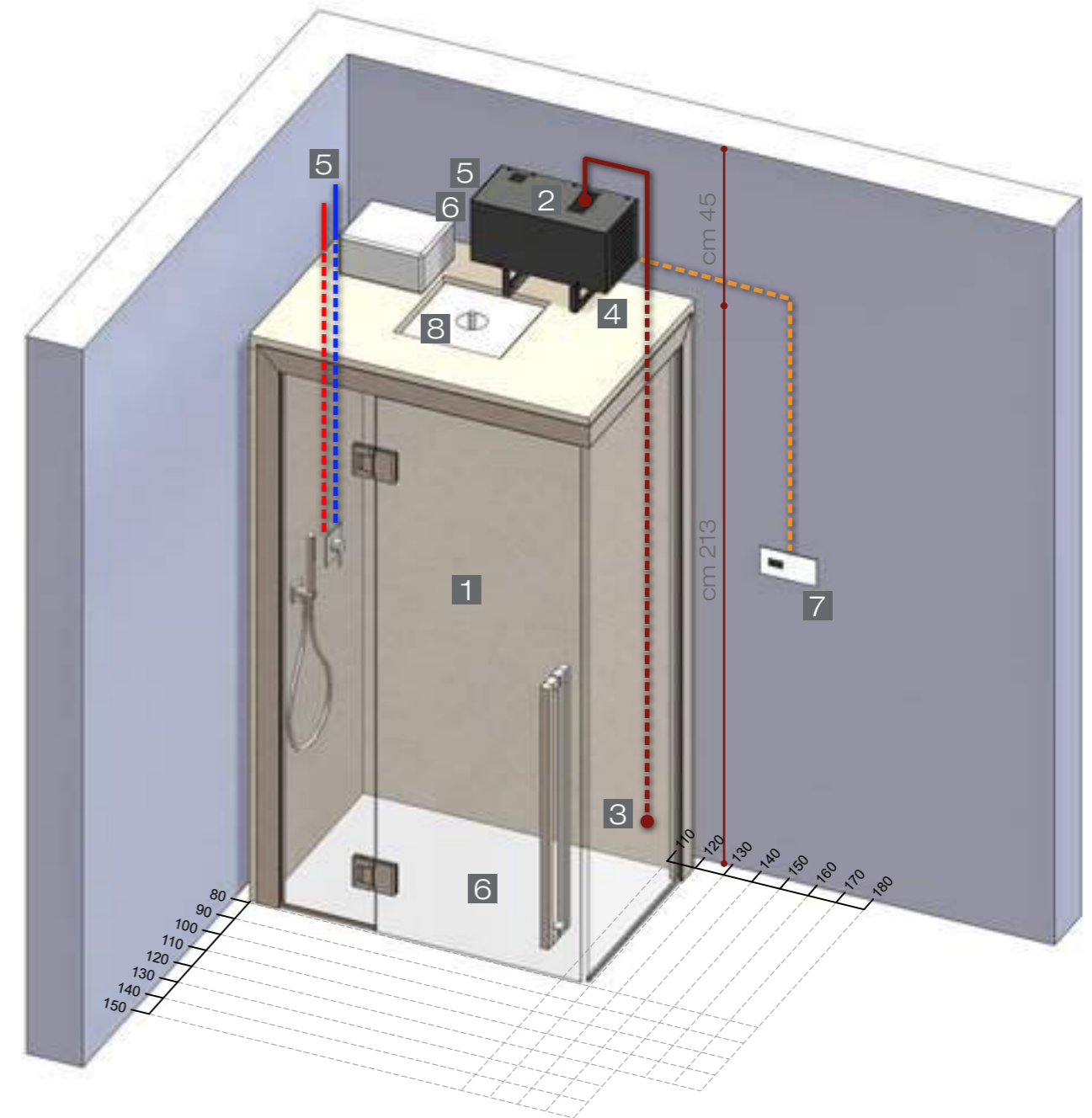

- 1** SteamShower  
*SteamShower*
- 2** Generatore di vapore  
*Steam generator*
- 3** Uscita vapore  
*Steam outlet*
- 4** Alimentazione elettrica  
*Power supply*
- 5** Collegamento acqua  
*Water supply*
- 6** Scarico  
*Drain*
- 7** Comandi vapore + luce  
*Steam + light controls*
- 8** Soffione doccia  
*Shower head*

# SteamShower S

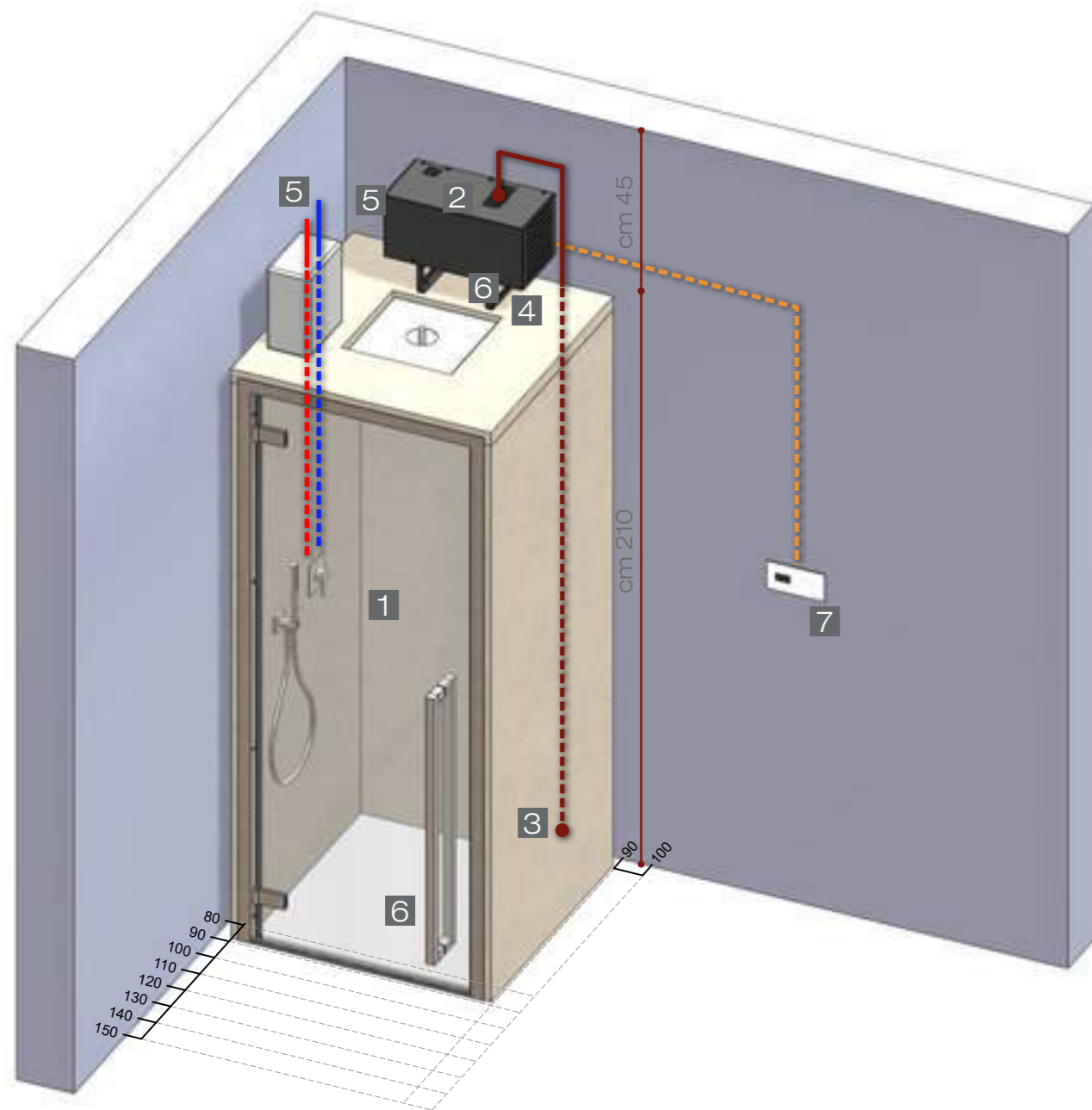

- 1** SteamShower  
SteamShower
- 2** Generatore di vapore  
Steam generator
- 3** Uscita vapore  
Steam outlet
- 4** Alimentazione elettrica  
Power supply
- 5** Collegamento acqua  
Water supply
- 6** Scarico  
Drain
- 7** Comandi vapore + luce  
Steam + light controls

## Scheda tecnica

Piastrellabile

Bianco / Tortora

Funzioni	Doccia vapore	
Temperatura	42°C	42°C
Doccia	Doccia Chromo inclusa; altri modelli optional.	Doccia Chromo inclusa; altri modelli optional.
Potenza elettrica	A seconda delle dimensioni	
Allacciamenti acqua	2-4 bar, 26 litri/ora, attacchi da 1/2" GAS UNI ISO 228/1	2-4 bar, 26 litri/ora, attacchi da 1/2" GAS UNI ISO 228/1
Materiale pareti	XPS	GRP
Spessore pareti	50 mm	50 mm
Panche	Optional	Optional
Pavimento	Optional	Optional
Porta	In cristallo temperato con telaio in alluminio. Luce netta di passaggio cm 70x199. Spessore: 8mm	In cristallo temperato con telaio in alluminio. Luce netta di passaggio cm 70x199. Spessore: 8mm
Illuminazione	A led RGB	A led RGB
A cura del Cliente	Massetto con piletta di scarico all'interno del box; allacciamenti acqua, scarichi, elettrici; impermeabilizzazione e rivestimenti.	Massetto con piletta di scarico all'interno del box; allacciamenti acqua, scarichi, elettrici.
Normative	CE	CE
Produzione	Made in Italy	Made in Italy

## Datasheet

Rough body

White / Dove grey

Functions	Steam shower	
Temperature	42°C	42°C
Shower	Chromo shower feature included; other models optional.	Chromo shower feature included; other models optional.
Power supply	Depending on size	
Water supply	2-4 bar, 26 litres/hour, connect. 1/2" GAS UNI ISO 228/1	2-4 bar, 26 litres/hour, connect. 1/2" GAS UNI ISO 228/1
Walls material	XPS	GRP
Wall thickness	50 mm	50 mm
Benches	Optional	Optional
Floor	Optional	Optional
Porta	Tempered glass with aluminium frame. Door clearance: cm 70x199. Thickness: 8mm	Tempered glass with aluminium frame. Door clearance: cm 70x199. Thickness: 8mm
Lighting	Led, RGB	Led, RGB
Preparations by Others	Screed with drain inside steam shower; water supply, drain and electric connection. After installation: waterproofing and tiling.	Screed with drain inside steam shower; water supply, drain and electric connection.
Norms	CE	CE
Production	Made in Italy	Made in Italy

**Panca mobile**

Sgabello Corinne in Corian™ e acciaio inox, con piedini regolabili. Misure cm 45x45x45h.

**Mobile seat**

Corinne seat made by Corian™ and stainless steel, with adjustable feet. Measurements cm 45x45x45h.

**Panca fissa piastrellabile**

Panca fissa piastrellabile, vedi sagome a dei bagni turchi SteamCustom.

**Fixed rough-body bench**

Fixed rough-body bench, to be tiled. See SteamCustom bench shapes.

**Panca fissa in ceramica**

Panca fissa in ceramica, con zampe trasparenti. Colori: vedi bagni turchi Moon.

**Fixed ceramic bench**

Fixed ceramic bench with transparent legs. Colours: see Moon steam baths.

**Pavimento**

Pavimento portante in pendenza con scarico, realizzato con lo stesso materiale delle pareti. Colori: bianco, tortora, oppure piastrellabile.

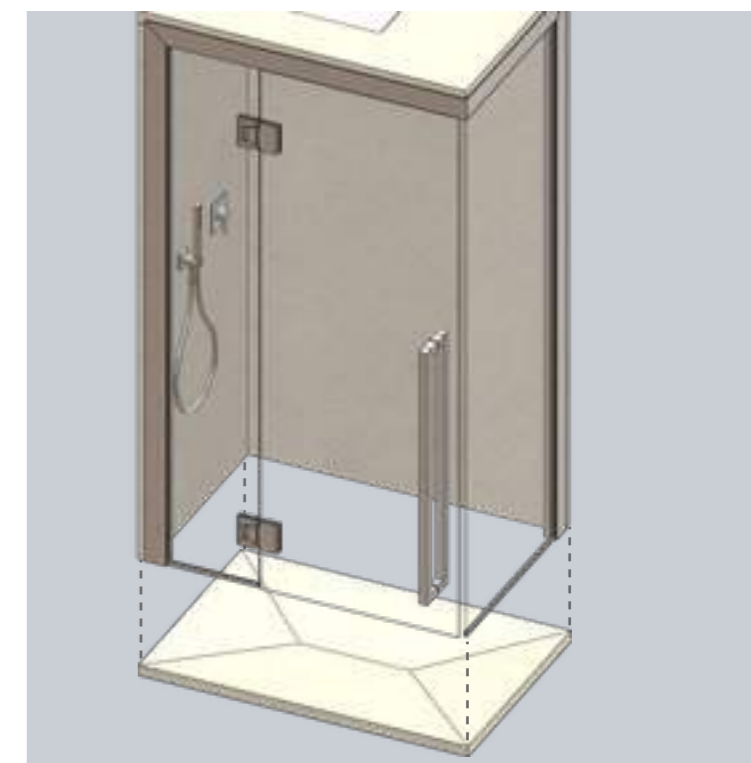
**Floor**

Sloping floor with drain, made with the same material as the walls. Colours: white, dove grey, or rough body.



la magia dell'acqua  
*the magic of water*





## Nebbia Fredda

Un velo impalpabile d'acqua fredda in combinazione con le note fresche dell'essenza Menta e il profondo relax di luci fredde che cambiano dolcemente colore.

## Cold mist

*A thin cold water mist, scented with fresh notes of Mint aroma and the deep relaxation of cold lights slowly changing colour.*



## Doccia a pioggia

Un getto d'acqua azionato dall'utente tramite il miscelatore, così da regolare a piacimento l'intensità, la durata e la temperatura. Accompagnato da un piacevole effetto cascata di luce bianca.

## Rain shower

*A jet of water controlled by a mixer that adjusts its intensity, duration and temperature. Accompanied by a pleasant white "light-fall" effect.*



## Doccia tropicale

Grosse gocce di acqua calda accompagnate da note aromatiche tropicali agli agrumi e l'effetto energizzante di luci calde che cambiano dolcemente colore.

## Tropical shower

*Large drops of warm water accompanied by tropical citrus fragrances and the energizing effect of warm lights slowly changing colour.*



## Miscelatore

Miscelatore monocomando integrato con la tastiera di attivazione degli effetti emozionali.

## Mixer

*Single-lever mixer integrated with the activation buttons of the experience effects.*



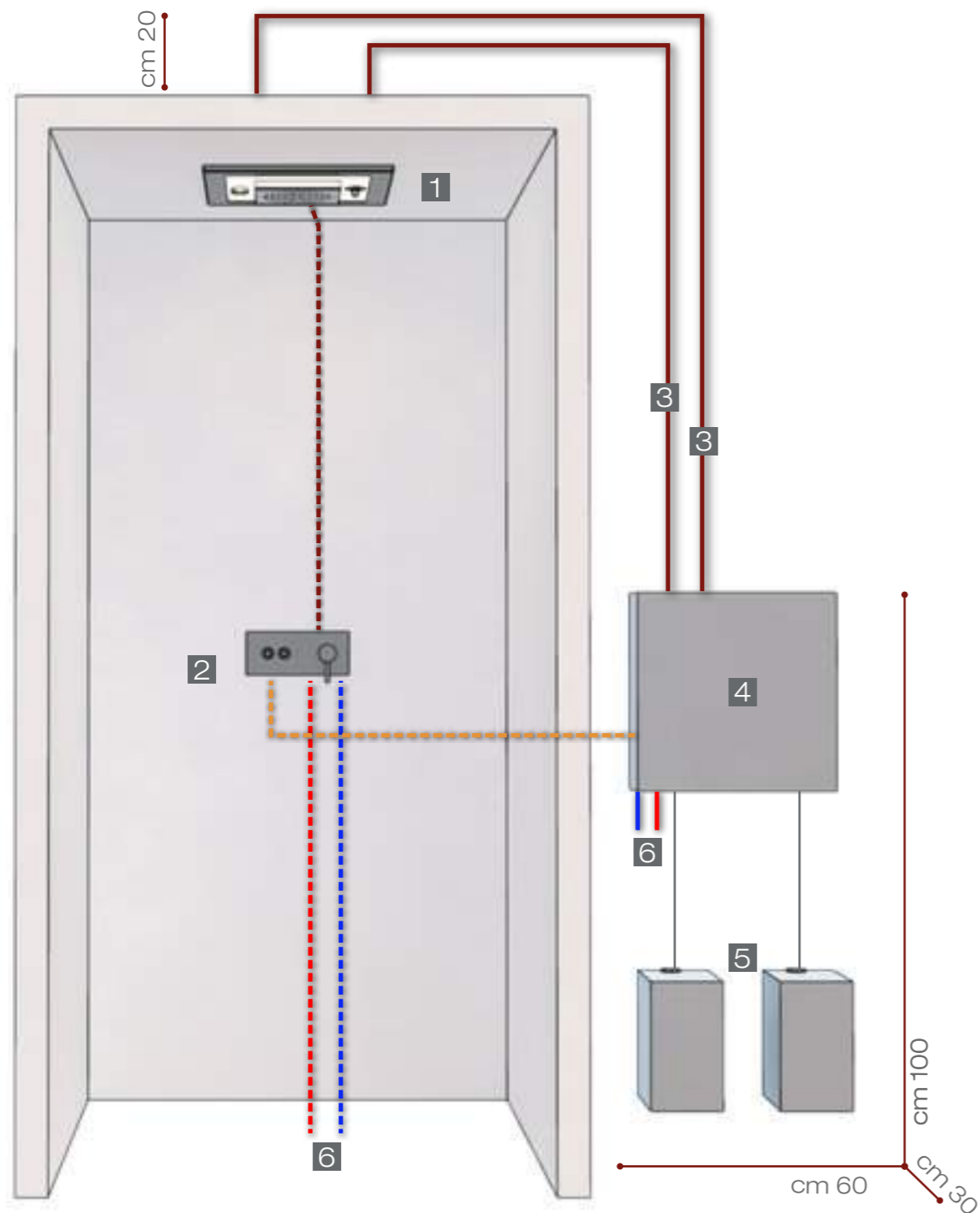

- 1** Plafone doccia emozionale  
*Showerhead*
- 2** Pulsanti di attivazione + miscelatore  
*Activation buttons + water mixer*
- 3** Collegamento elettrico/idraulico  
*Electric / Hydraulic connections*
- 4** Quadro tecnico  
*Control panel*
- 5** Tanciche di essenze  
*Aroma tanks*
- 6** Alimentazione acqua  
*Water supply*

## Scheda tecnica

Dimensioni plafone	cm 45x45
Illuminazione	RGB a LED con transizioni lente
Alimentazione elettrica	100 W, 230V AC, 0,43 A
Alimentazione idraulica	calda + fredda, 2-4 bar, 26 litri/min, attacchi da 1/2" GAS UNI ISO 228/1
Tipo di pompe aromi	Pompe a membrana
Imballo	cm 60x60x40
Peso Kg	20
Distanza dal vano tecnico	Max 7 metri lunghezza tubi
Altezza consigliata	cm 220
Normative	CE, su richiesta UL/ETL
Produzione	Made in Italy

## Datasheet

<i>Showerhead size</i>	<i>cm 45x45</i>
<i>Lighting</i>	<i>Slow colour-changing LED RGB lighting system</i>
<i>Power supply</i>	<i>100 W, 230V AC, 0,43 A</i>
<i>Water supply</i>	<i>warm + cold, 2-4 bar, 26 litres/min, connections 1/2" GAS UNI ISO 228/1</i>
<i>Aroma pumps type</i>	<i>Diaphragm pumps</i>
<i>Package</i>	<i>cm 60x60x40</i>
<i>Weight Kg</i>	<i>20</i>
<i>Distance from plant room</i>	<i>Maximum pipe length 7 metres</i>
<i>Recommended height</i>	<i>cm 220</i>
<i>Norms</i>	<i>CE, on request UL/ETL</i>
<i>Production</i>	<i>Made in Italy</i>

# Ray Plus



## Nebbia Fredda

Un velo impalpabile d'acqua fredda in combinazione con le note fresche dell'essenza Menta e il profondo relax di luci fredde che cambiano dolcemente colore.

## Cold mist

*A thin cold water mist, scented with fresh notes of Mint aroma and the deep relaxation of cold lights slowly changing colour.*



## Doccia a pioggia

Un getto d'acqua azionato dall'utente tramite il miscelatore, così da regolare a piacimento l'intensità, la durata e la temperatura. Accompagnato da un piacevole effetto cascata di luce bianca.

## Rain shower

*A jet of water controlled by a mixer that adjusts its intensity, duration and temperature. Accompanied by a pleasant white "light-fall" effect.*



## Doccia tropicale

Grosse gocce di acqua calda accompagnate da note aromatiche tropicali agli agrumi e l'effetto energizzante di luci calde che cambiano dolcemente colore.

## Tropical shower

*Large drops of warm water accompanied by tropical citrus fragrances and the energizing effect of warm lights slowly changing colour.*



## Doccino flessibile

Rubinetteria di elevatissima qualità, miscelatore termostatico e doccino flessibile per riscoprire tutto il piacere di un'esperienza di benessere all'altezza delle migliori SPA.

## Flexible hand shower

*Top quality fittings and fixtures, thermostatic mixer and flexible hand shower to rediscover the pleasure of a wellness experience worthy of a luxury SPA.*



## Scheda tecnica

Dimensioni plafone	cm 45x45
Illuminazione	RGB a LED con transizioni lente
Alimentazione elettrica	100 W, 230V AC, 0,43 A
Alimentazione idraulica	calda + fredda, 2-4 bar, 26 litri/min, attacchi da 1/2" GAS UNI ISO 228/1
Tipo di pompe aromi	Pompe a membrana
Imballo	cm 60x60x40
Peso Kg	20
Distanza dal vano tecnico	Max 7 metri lunghezza tubi
Altezza consigliata	cm 220
Normative	CE, su richiesta UL/ETL
Produzione	Made in Italy

## Datasheet

Showerhead size	cm 45x45
Lighting	Slow colour-changing LED RGB lighting system
Power supply	100 W, 230V AC, 0,43 A
Water supply	warm + cold, 2-4 bar, 26 litres/min, connections 1/2" GAS UNI ISO 228/1
Aroma pumps type	Diaphragm pumps
Package	cm 60x60x40
Weight Kg	20
Distance from plant room	Maximum pipe length 7 metres
Recommended height	cm 220
Norms	CE, on request UL/ETL
Production	Made in Italy

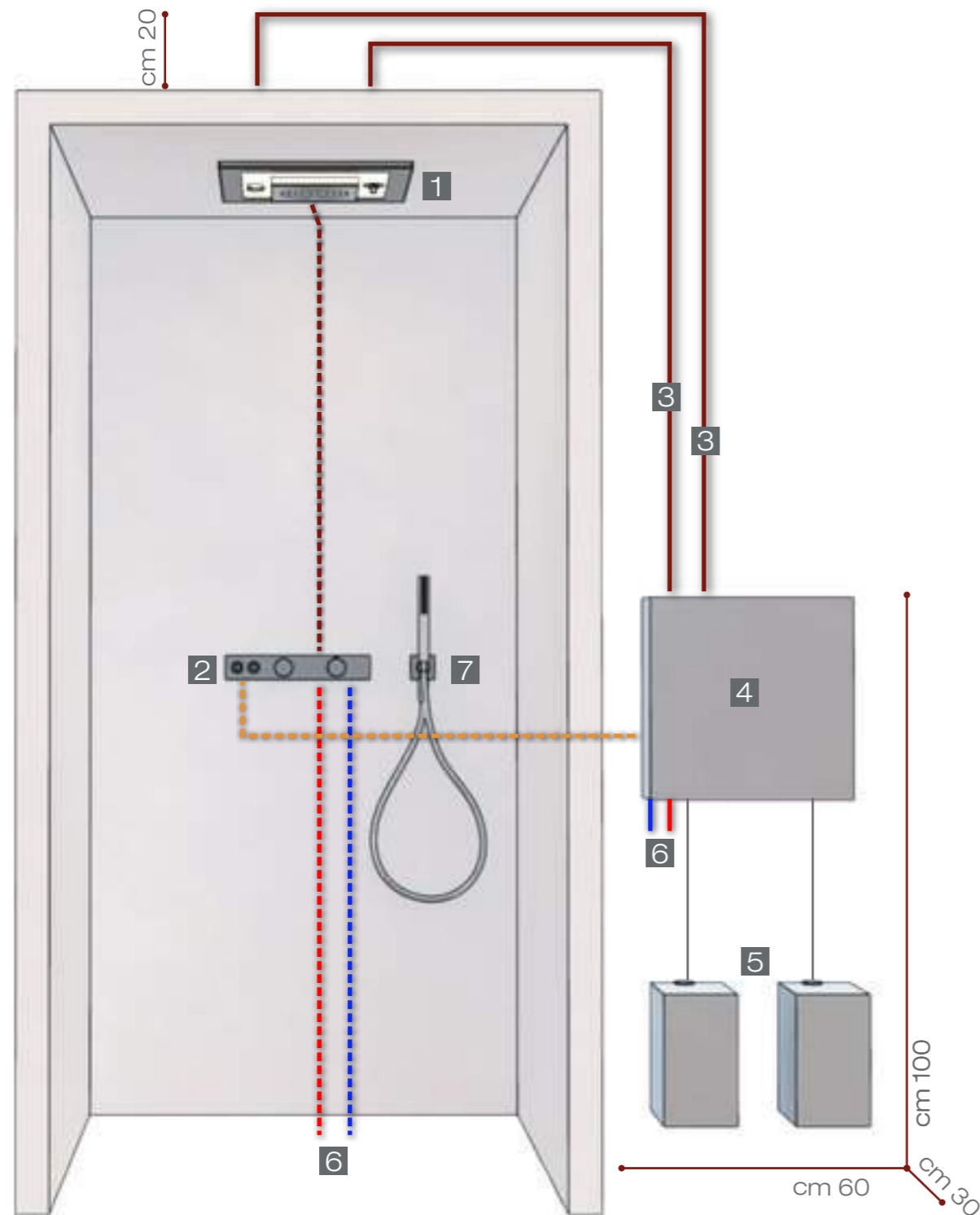

- 1 Plafone doccia emozionale  
Showerhead
- 2 Pulsanti di attivazione + miscelatore  
Activation buttons + water mixer
- 3 Collegamento elettrico/idraulico  
Electric / Hydraulic connections
- 4 Quadro tecnico  
Control panel
- 5 Taniche di essenze  
Aroma tanks
- 6 Alimentazione acqua  
Water supply
- 7 Doccino flessibile  
Flexible handshower



# Chromo

## Doccia a pioggia

Un getto d'acqua azionato dall'utente tramite il miscelatore, così da regolare a piacimento l'intensità, la durata e la temperatura. Accompagnato da un piacevole effetto cascata di luce bianca.

## Rain shower

*A jet of water controlled by a mixer that adjusts its intensity, duration and temperature. Accompanied by a pleasant white "light-fall" effect.*



## CromoLux rilassante

Il profondo relax di luci fredde che cambiano dolcemente colore.

## Relaxing CromoLux

*The deep relaxation of cold lights slowly changing colour.*



## CromoLux energizzante

L'effetto energizzante di luci calde che cambiano dolcemente colore.

## Tropical shower

*The energizing effect of warm lights slowly changing colour.*



## Doccino flessibile

Il doccino flessibile collegato al miscelatore la rende una doccia adatta a tutte le occasioni.

## Flexible hand shower

*The flexible hand shower controlled by the mixer makes this shower ideal for all purposes.*



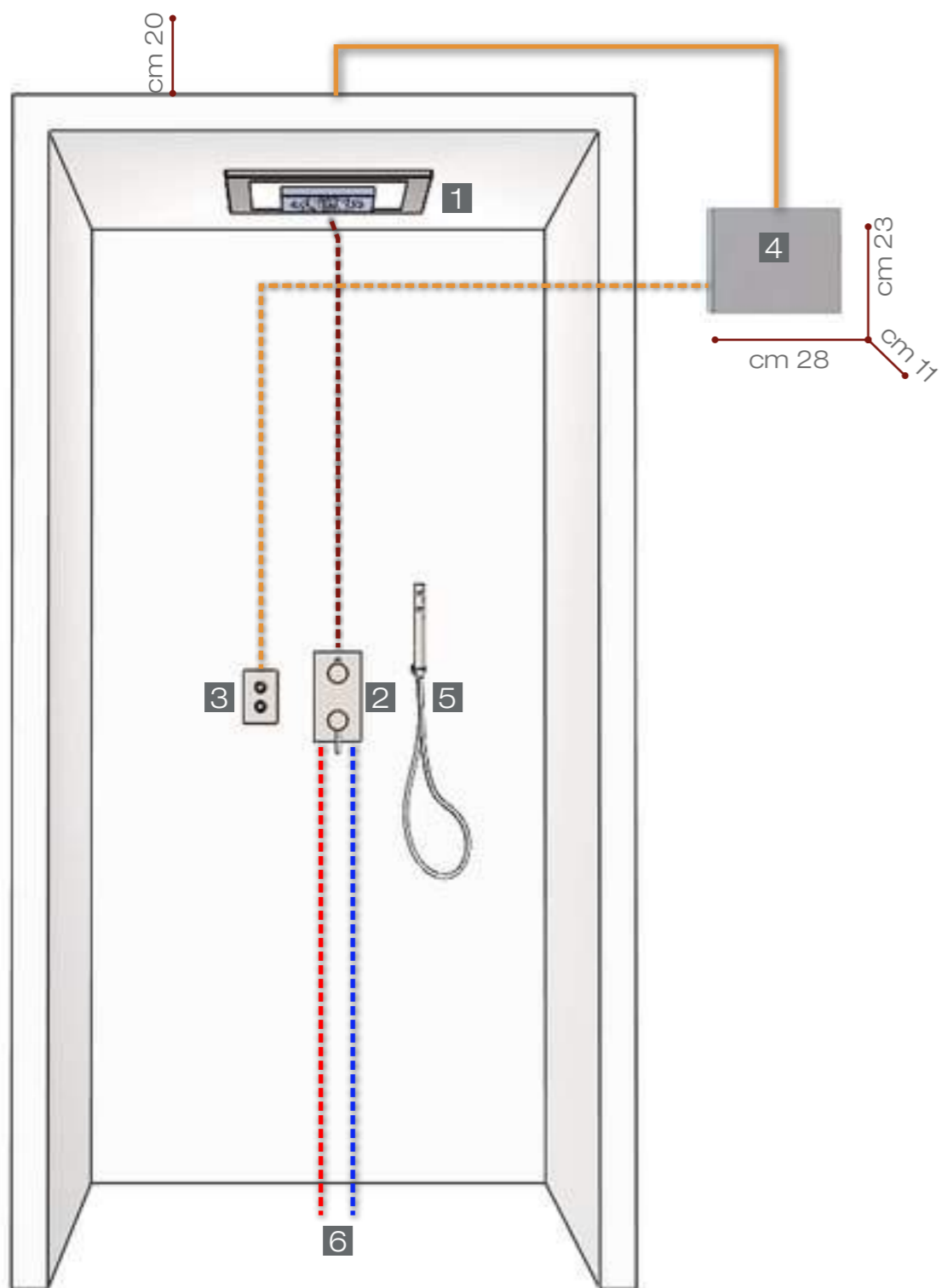

- 1** Plafone doccia  
Showerhead
- 2** Miscelatore + deviatore  
Water mixer + diverter
- 3** Pulsanti di attivazione effetti chromo  
Chromo effects activation buttons
- 4** Quadro elettrico  
Electrical panel
- 5** Doccino flessibile  
Flexible handshower
- 6** Alimentazione acqua  
Water supply

## Scheda tecnica

Dimensioni plafone	cm 45x45
Illuminazione	RGB a LED con transizioni lente
Alimentazione elettrica	50 W, 230V AC, 0,22 A
Alimentazione idraulica	calda + fredda, 2-4 bar, 26 litri/min, attacchi da 1/2" GAS UNI ISO 228/1
Imballo	cm 60x60x40
Peso Kg	12
Distanza dal vano tecnico	Qualsiasi
Altezza consigliata	cm 220
Normative	CE, su richiesta UL/ETL
Produzione	Made in Italy

## Datasheet

Showerhead size	cm 45x45
Lighting	Slow colour-changing LED RGB lighting system
Power supply	50 W, 230V AC, 0,22 A
Water supply	warm + cold, 2-4 bar, 26 litres/min, connections 1/2" GAS UNI ISO 228/1
Package	cm 60x60x40
Weight Kg	12
Distance from plant room	Any
Recommended height	cm 220
Norms	CE, on request UL/ETL
Production	Made in Italy

# Island



## Nebbia Fredda

Un velo impalpabile d'acqua fredda in combinazione con le note fresche dell'essenza Menta e il profondo relax della luce blu.

## Cold mist

*A thin cold water mist, scented with fresh notes of Mint aroma and illuminated by deeply relaxing blue light.*

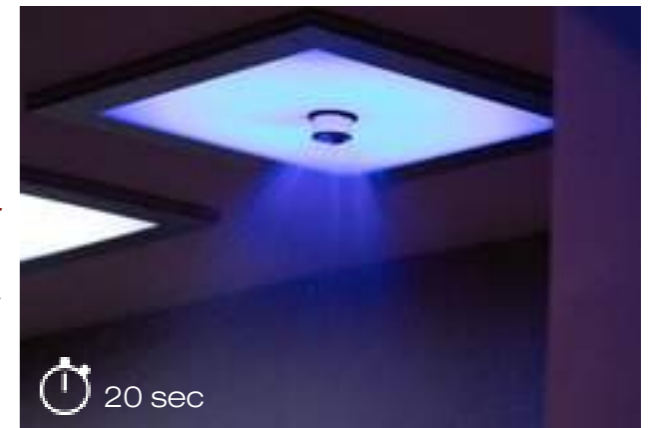

## Doccia tropicale

Grosse gocce di acqua calda accompagnate da luce arancione e da note aromatiche tropicali agli agrumi.

## Tropical shower

*Large drops of warm water synchronized with orange light and scented with tropical citrus fragrances.*



## Doccia velo d'acqua

Doccia tiepida dall'alto tramite due lame d'acqua, con dosaggio di essenza Blu Relax e luce verde.

## Veil shower

*Two blades of body temperature water from above, scented with Blu Relax aroma and illuminated by green light.*



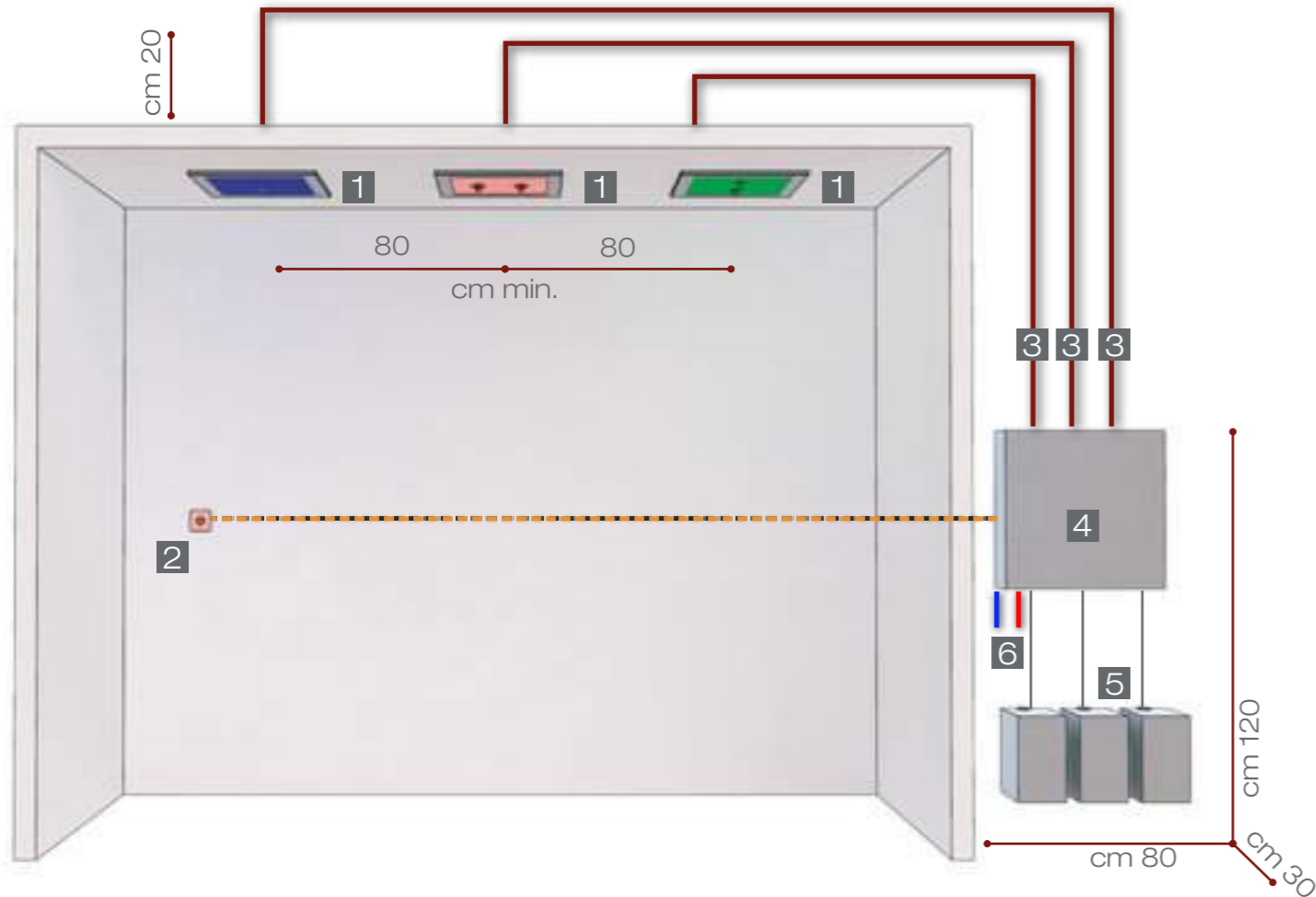

- 1** Plafoni doccia emozionale  
*Showerheads*
- 2** Pulsante start  
*Start button*
- 3** Collegamento elettrico/idraulico  
*Electric / Hydraulic connections*
- 4** Quadro tecnico  
*Control panel*
- 5** Taniche di essenze  
*Aroma tanks*
- 6** Alimentazione acqua  
*Water supply*

## Scheda tecnica

Numero di effetti	3
Dimensioni plafoni	cm 45x45
Funzionamento	Premendo il pulsante start, si attivano gli effetti in sequenza uno dopo l'altro
Illuminazione	RGB a LED
Alimentazione elettrica	100 W, 230V AC, 0,43 A
Alimentazione idraulica	calda + fredda, 2-4 bar, 26 litri/min, attacchi da 1/2" GAS UNI ISO 228/1
Tipo di pompe aromi	Pompe a membrana
Imballo	cm 60x60x40 x2
Peso Kg	40
Distanza dal vano tecnico	Max 7 metri lunghezza tubi
Altezza consigliata	cm 220
Normative	CE, su richiesta UL/ETL
Produzione	Made in Italy

## Datasheet

<i>Number of effects</i>	3
<i>Showerheads size</i>	cm 45x45
<i>Functioning</i>	Press the start button and the effects will start in a sequence, one after another
<i>Lighting</i>	LED RGB lighting system
<i>Power supply</i>	100 W, 230V AC, 0,43 A
<i>Water supply</i>	warm + cold, 2-4 bar, 26 litres/min, connections 1/2" GAS UNI ISO 228/1
<i>Aroma pumps type</i>	Diaphragm pumps
<i>Package</i>	cm 60x60x40 x2
<i>Weight Kg</i>	40
<i>Distance from plant room</i>	Maximum pipe length 7 metres
<i>Recommended height</i>	cm 220
<i>Norms</i>	CE, on request UL/ETL
<i>Production</i>	Made in Italy



# Paradise

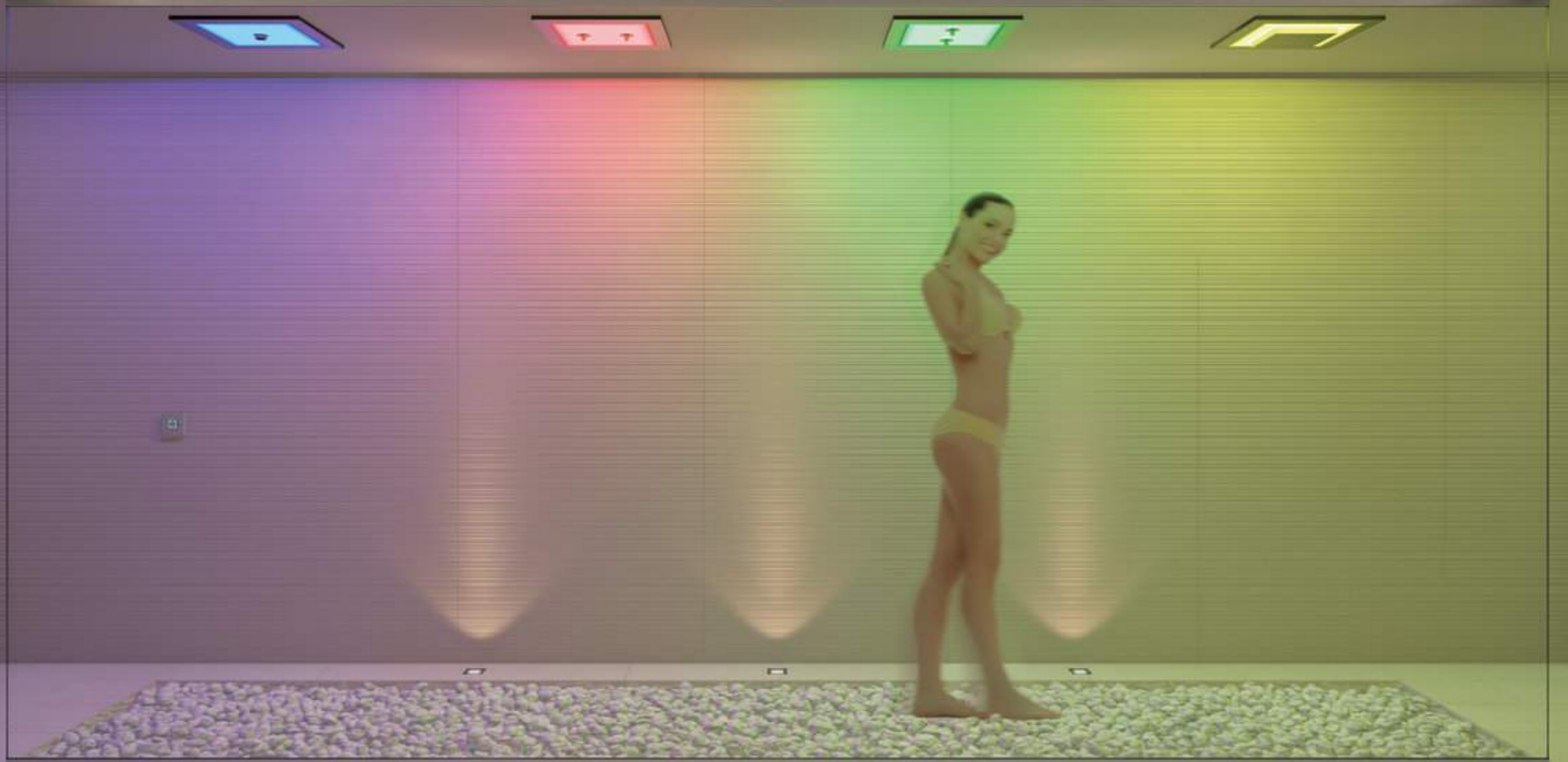

### Nebbia Fredda

Un velo impalpabile d'acqua fredda in combinazione con le note fresche dell'essenza Menta e il profondo relax della luce blu.

#### *Cold mist*

*A thin cold water mist, scented with fresh notes of Mint aroma and illuminated by deeply relaxing blue light.*



### Doccia tropicale

Grosse gocce di acqua calda accompagnate da luce arancione e da note aromatiche tropicali agli agrumi.

#### *Tropical shower*

*Large drops of warm water synchronized with orange light and scented with tropical citrus fragrances.*



### Doccia velo d'acqua

Doccia tiepida dall'alto tramite due lame d'acqua, con dosaggio di essenza Blu Relax e luce verde.

#### *Veil shower*

*Two blades of body temperature water from above, scented with Blu Relax aroma and illuminated by green light.*



### Doccia a pioggia

Doccia tiepida dall'alto tramite soffione a pioggia, con luce gialla rivitalizzante.

#### *Rain shower*

*Body temperature rain shower from above, illuminated by revitalizing yellow light.*



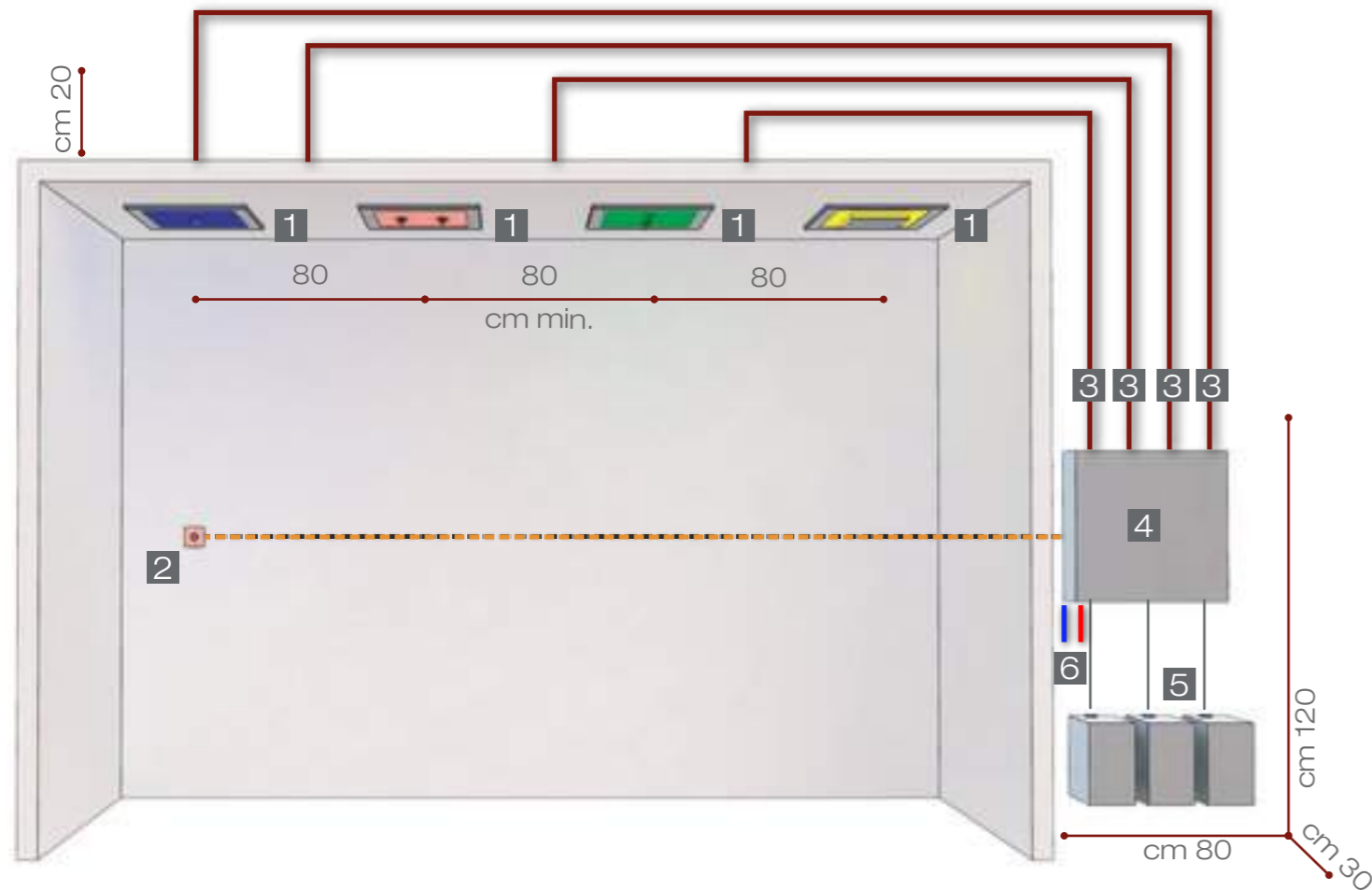

- 1** Plafoni doccia emozionale  
*Showerheads*
- 2** Pulsante start  
*Start button*
- 3** Collegamento elettrico/idraulico  
*Electric / Hydraulic connections*
- 4** Quadro tecnico  
*Control panel*
- 5** Taniche di essenze  
*Aroma tanks*
- 6** Alimentazione acqua  
*Water supply*

## Scheda tecnica

Numero di effetti	4
Dimensioni plafoni	cm 45x45
Funzionamento	Premendo il pulsante start, si attivano gli effetti in sequenza uno dopo l'altro
Illuminazione	RGB a LED
Alimentazione elettrica	100 W, 230V AC, 0,43 A
Alimentazione idraulica	calda + fredda, 2-4 bar, 26 litri/min, attacchi da 1/2" GAS UNI ISO 228/1
Tipo di pompe aromi	Pompe a membrana
Imballo	cm 60x60x60 x2
Peso Kg	40
Distanza dal vano tecnico	Max 7 metri lunghezza tubi
Altezza consigliata	cm 220
Normative	CE, su richiesta UL/ETL
Produzione	Made in Italy

## Datasheet

<i>Number of effects</i>	4
<i>Showerheads size</i>	cm 45x45
<i>Functioning</i>	<i>Press the start button and the effects will start in a sequence, one after another</i>
<i>Lighting</i>	<i>LED RGB lighting system</i>
<i>Power supply</i>	<i>100 W, 230V AC, 0,43 A</i>
<i>Water supply</i>	<i>warm + cold, 2-4 bar, 26 litres/min, connections 1/2" GAS UNI ISO 228/1</i>
<i>Aroma pumps type</i>	<i>Diaphragm pumps</i>
<i>Package</i>	<i>cm 60x60x60 x2</i>
<i>Weight Kg</i>	40
<i>Distance from plant room</i>	<i>Maximum pipe length 7 metres</i>
<i>Recommended height</i>	cm 220
<i>Norms</i>	CE, on request UL/ETL
<i>Production</i>	Made in Italy

# Scozia



Hotel Soleil, Jesolo, Italy

## Scheda tecnica

Funzionamento	Doccia con 6 getti d'acqua (3 per parte) a goccioloni massaggianti, la temperatura si alterna velocemente caldo/freddo. Attivazione tramite pulsante, effetto temporizzato 40 secondi.
Illuminazione	Faretto a LED bianco
Alimentazione elettrica	100 W, 230V AC, 0,43 A
Alimentazione idraulica	calda + fredda, 2-4 bar, 36 litri/min, attacchi da 1/2" GAS UNI ISO 228/1
Imballo	cm 60x60x40
Peso Kg	20
Distanza dal vano tecnico	Max 7 metri lunghezza tubi
Altezza consigliata	cm 50 / 100 / 150 da terra
Normative	CE, su richiesta UL/ETL
Produzione	Made in Italy

## Datasheet

How it works	Shower with 6 massaging water jets (3 each side), temperature alternates rapidly between cold and hot. Activation with button, time-controlled effect 40 seconds.
Lighting	White LED spot light
Power supply	100 W, 230V AC, 0,43 A
Water supply	warm + cold, 2-4 bar, 36 litres/min, connections 1/2" GAS UNI ISO 228/1
Package	cm 60x60x40
Weight Kg	20
Distance from plant room	Maximum pipe length 7 metres
Recommended height	cm 50 / 100 / 150 from the ground
Norms	CE, on request UL/ETL
Production	Made in Italy

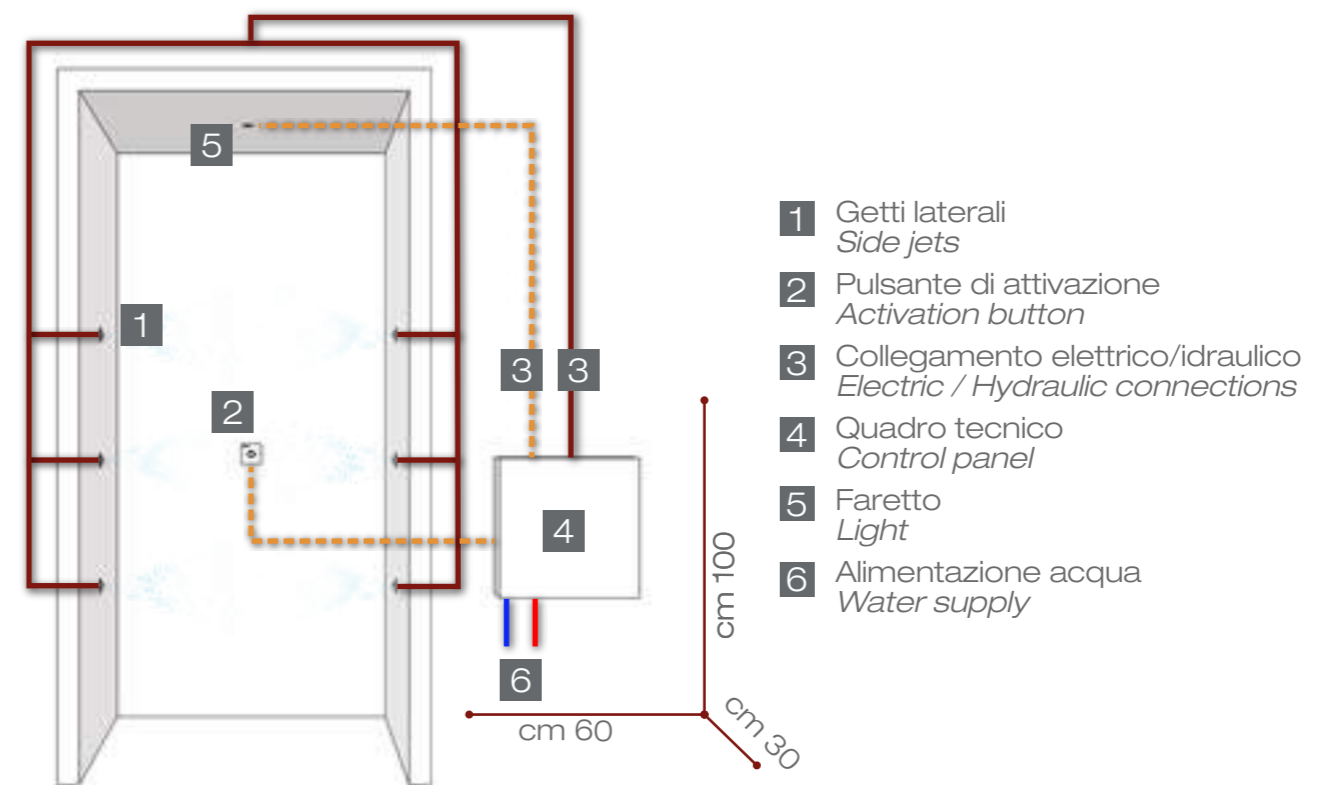



## Funzioni

Volga Mekong Chromo Ray Ray Plus

	Doccia nebbia fredda con aroma Menta <i>Cold mist shower with Mint aroma</i>	•	-	-	•	•
	CromoLux rilassante <i>Relaxing CromoLux</i>	•	-	•	•	•
	Doccia tropicale con aroma Tropic <i>Tropical shower with Tropic aroma</i>	-	•	-	•	•
	CromoLux energizzante <i>Energising CromoLux</i>	-	•	•	•	•
	Doccia a pioggia <i>Rain shower</i>	•	•	•	•	-
	Doccia a pioggia Plus <i>Rain shower Plus</i>	-	-	-	-	•
	Miscelatore monocomando <i>Single control water mixer</i>	•	•	•	•	-
	Miscelatore termostatico <i>Thermostatic water mixer</i>	-	-	-	-	•
	Doccino flessibile <i>Flexible hand shower</i>	-	-	•	-	•
	Luce di cortesia <i>Courtesy light</i>	•	•	•	•	•
	Getti laterali <i>Side jets</i>	○	○	○	○	○

- Incluso di serie
- Optional
- Non compatibile

## Funzioni

Island Paradise

	Doccia nebbia fredda con aroma Menta <i>Cold mist shower with Mint aroma</i>	•	•
	CromoLux rilassante <i>Relaxing CromoLux</i>	•	•
	Doccia tropicale con aroma Tropic <i>Tropical shower with Tropic aroma</i>	•	•
	CromoLux energizzante <i>Energising CromoLux</i>	•	•
	Doccia velo d'acqua con aroma Blu Relax <i>Water veil shower with Blu Relax aroma</i>	•	•
	CromoLux riequilibrante <i>Rebalancing CromoLux</i>	•	•
	Doccia a pioggia <i>Rain shower</i>	-	•
	CromoLux tonificante <i>Toning CromoLux</i>	-	•
	Luce di cortesia <i>Courtesy light</i>	•	•
	Getti laterali <i>Side jets</i>	○	○

- Included
- Optional
- Not available

# Doccia rustica

## Bucket shower



### Scheda tecnica

Funzioni	Doccia rivitalizzante per rinfrescare intensamente e velocemente il corpo
Materiale	Larice verniciato
Capacità	10 litri
Allacciamento	Acqua fredda, 2-4 bar, attacco da 1/2" M GAS UNI ISO 228/1
Fissaggio	Parete / Soffitto
Riempimento automatico	Incluso
Funzionamento	Tirando una catenella lunga 65 cm, il mastello rovescia di colpo l'acqua in esso contenuta sulla persona sottostante.
Imballo	cm 50x40x40
Peso	10 Kg
Altezza locale	Minima: cm 250. Consigliata: cm 270.

### Datasheet

Features	<i>A revitalising shower that has a quick and intense refreshing effect on the body</i>
Material	<i>Painted larch</i>
Capacity	<i>10 litres</i>
Water supply	<i>Cold water, 2-4 bar, connection 1/2" M GAS UNI ISO 228/1</i>
Installation	<i>Wall / Ceiling</i>
Automatic refill	<i>Included</i>
Activation	<i>By pulling a 65 cm long chain, the bucket tips the water over the person standing below.</i>
Packaging	<i>cm 50x40x40</i>
Weight	<i>10 Kg</i>
Room height	<i>Minimum: cm 250. Recommended: cm 270.</i>

# Percorsi Kneipp

*Kneipp paths*





## Scheda tecnica

Funzione	Nel percorso Kneipp vengono alternati bagni caldi e freddi, dove i piedi e le gambe vengono massaggiati dolcemente da piccoli ma intensi spruzzi di acqua.
Benefici	Questo trattamento ha straordinari effetti benefici sulla circolazione sanguigna, con un effetto immediato di tonificazione e defaticamento.
Attivazione	Pulsante di Start (fornito) da collocare in prossimità della vasca.
Temperatura consigliata	38°C (compartimenti caldi), 17°C o temperature di mandata (compartimenti freddi)
Compartimenti	Secondo progetto, da 1 a 16
Dimensioni vasche	0,3 - 0,4 m <sup>2</sup>
Alimentazione idraulica	calda + fredda, 2-4 bar, 16 litri/min, attacchi da 1/2" GAS UNI ISO 228/1
Potenza	100 W, 230V AC, 0,43 A
Predisposizioni	Alimentazione elettrica; allacciamento acqua calda e fredda nel vano tecnico; tubi dal vano tecnico agli ugelli nella vasca con raccordo 1/2" F
Produzione	Made in Italy

## Datasheet

Function	The Kneipp path alternates hot and cold baths where feet and legs are pleasantly massaged by small but intense jets of water.
Benefits	This path has a wonderful beneficial effect on blood circulation, providing an immediate toning and energising effect.
Activation	Start button (included) to be placed near the path.
Recommended temperature	38°C (hot compartment), 17°C or supply water (cold compartment)
Compartments	According to project, 1 to 16
Compartment size	0,3 - 0,4 m <sup>2</sup>
Water supply	warm + cold, 2-4 bar, 16 litres/min, connections 1/2" GAS UNI ISO 228/1
Power supply	100 W, 230V AC, 0,43 A
Preparations	Power supply; hot and cold water supply in the plant room; pipes from the plant room to the nozzles in the baths with 1/2" F connection
Production	Made in Italy

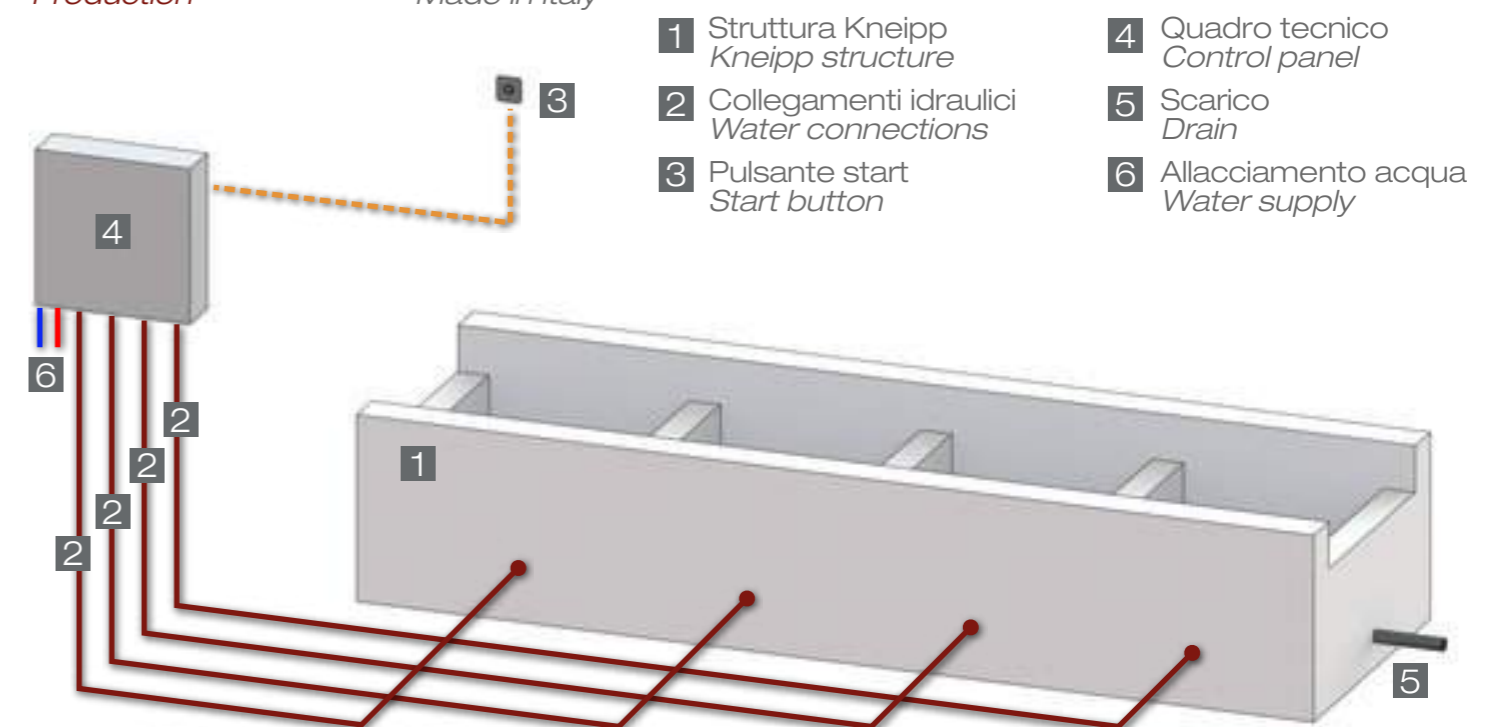



# Ghiaccio

ice



## Cascata di ghiaccio

## Ice fall

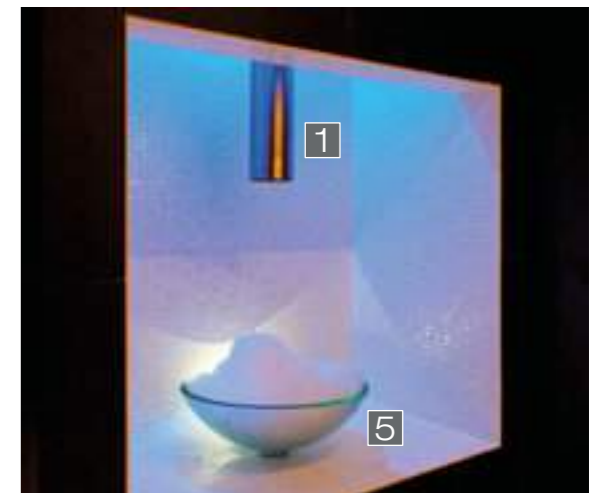

- 1 Scivolo a soffitto  
*Ceiling slide*
- 2 Scivolo a parete  
*Wall slide*
- 3 Vaschetta ghiaccio piastrellabile  
*Rough body ice bowl*
- 4 Vaschetta ghiaccio Arctic  
*Arctic ice bowl*
- 5 Vaschetta di cristallo  
*Crystal ice bowl*

## Installazione a controsoffitto Ceiling installation

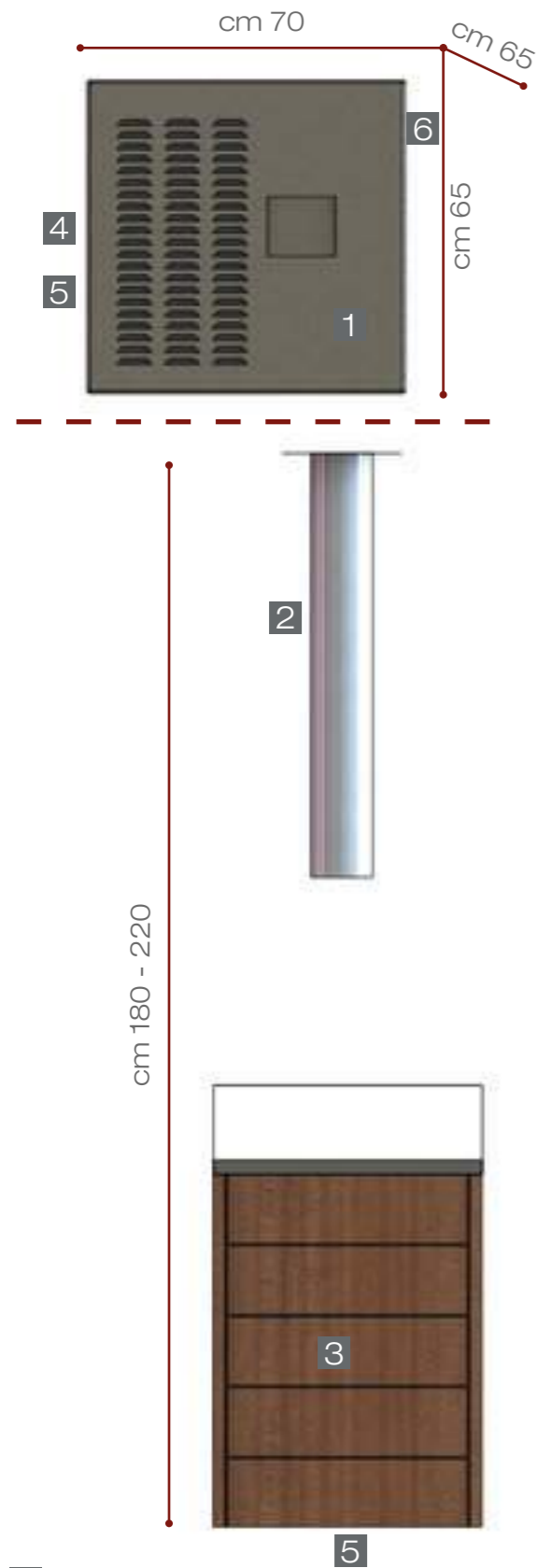

- 1** Produttore di ghiaccio
- 2** Scivolo
- 3** Vaschetta
- 4** Allacciamenti acqua / corrente
- 5** Scarico
- 6** Indicatore di stato

## Installazione a vano tecnico Plant room installation

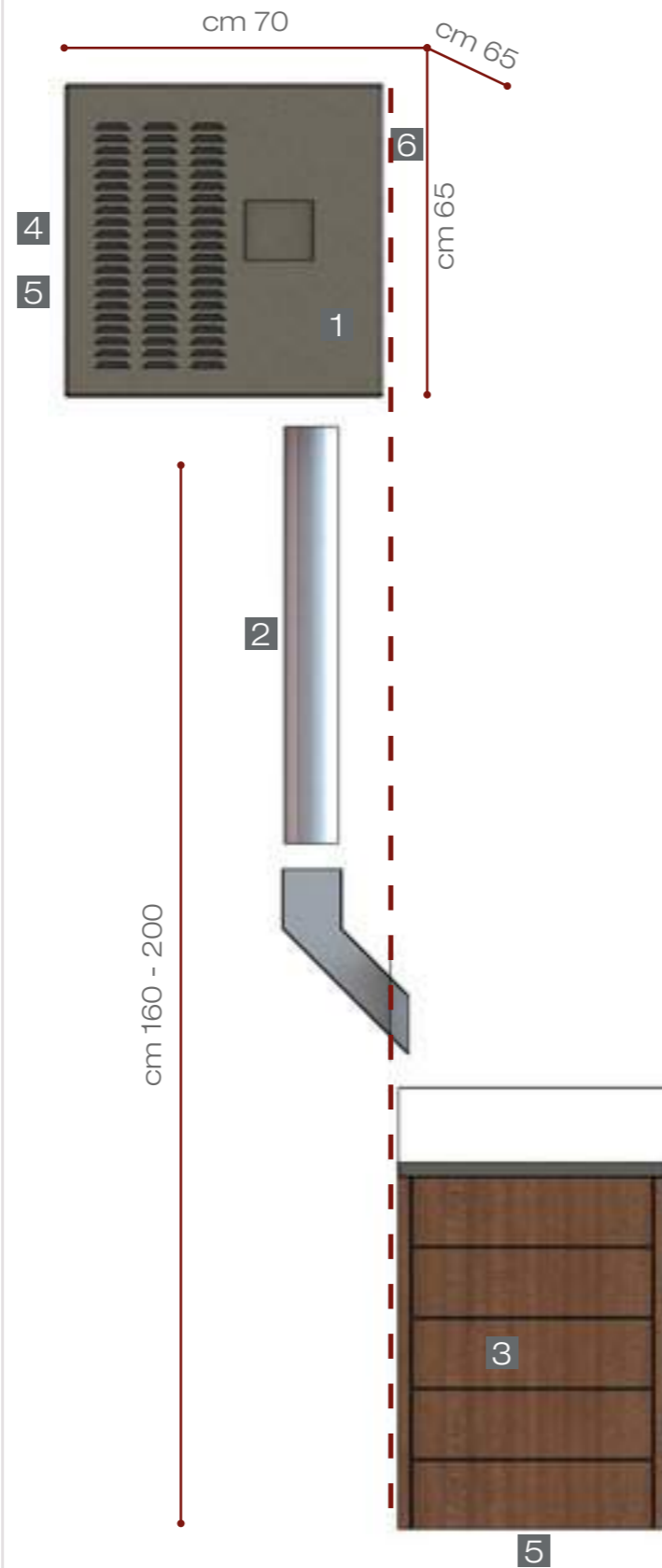

- 1** Ice machine
- 2** Slide
- 3** Collection bowl
- 4** Power + water connections
- 5** Drain
- 6** Status indicator

## Scheda tecnica

**GH1**

**GH2**

Funzioni	Cascata di ghiaccio in scaglie per il raffreddamento dopo sauna e bagno turco	
Raffreddamento	Ad acqua	Ad acqua
Refrigerante	R 134°	R 134°
Sistema di controllo	Timer opzionale	Timer opzionale
Alimentazione elettrica	500 W, 230 VAC, 2,2 A	760 W, 230 VAC, 3,3 A
Allacciamento acqua	Acqua fredda, 2-4 bar, 30 litri/ora, attacchi 2x 3/4" GAS UNI ISO 228/1	Acqua fredda, 2-4 bar, 102 litri/ora, attacchi 2x 3/4" GAS UNI ISO 228/1
Produzione max/ora	120 Kg in 24 ore, pari a 5 Kg / ora	200 Kg in 24 ore, pari a 8,3 Kg / ora
Calore generato	968 W	2365 W
Imballo	cm 63 x 61 x 69h	cm 65 x 61 x 69h
Peso Kg	52	57
A cura del Cliente	Staffa di fissaggio, allacciamento acqua, scarico, allacciamento elettrico	Staffa di fissaggio, allacciamento acqua, scarico, allacciamento elettrico
Ingombro nel vano tecnico	cm 70 x 70 x 70h	cm 70 x 70 x 70h
Normative	CE	CE
Produzione	Made in Italy	Made in Italy

## Datasheet

**GH1**

**GH2**

Functions	Ice fall for refreshing after sauna or steam bath	
Cooling system	Water cooling	Water cooling
Cooling gas	R 134°	R 134°
Control system	Optional timer	Optional timer
Power supply	500 W, 230 VAC, 2,2 A	760 W, 230 VAC, 3,3 A
Water supply	Cold water, 2-4 bar, 30 litres/hour, connect. 2x 3/4" GAS UNI ISO 228/1	Cold water, 2-4 bar, 102 litres/hour, connect. 2x 3/4" GAS UNI ISO 228/1
Production max/hour	120 Kg in 24 hours, a 5 Kg / hour	200 Kg in 24 hours, 8,3 Kg / hour
Generated heat	968 W	2365 W
Packing size	cm 63 x 61 x 69h	cm 65 x 61 x 69h
Weight Kg	52	57
Preparations by Others	Fixing bracket, water supply, drain, power supply	Fixing bracket, water supply, drain, power supply
Plant room size	cm 70 x 70 x 70h	cm 70 x 70 x 70h
Norms	CE	CE
Production	Made in Italy	Made in Italy

# Polaris





## Scheda tecnica

Funzioni	Parete di ghiaccio
Dimensioni	cm 90,5 x 50 x 195,5h
Materiale	Acciaio inox satinato
Assorbimento elettrico	485 W, 230 VAC, 3,5 A
Temperatura ambiente	28°C Max
Calore generato	2300 Watt smaltiti in calore ambiente
Peso Kg	120
Allacciamento acqua e scarico	Non necessari
Gas refrigerante	R134A
Produzione	Made in Italy

## Datasheet

<i>Function</i>	<i>Ice wall</i>
<i>Dimensions</i>	<i>cm 90,5 x 50 x 195,5h</i>
<i>Material</i>	<i>Stainless steel, satin</i>
<i>Power</i>	<i>485 W, 230 VAC, 3,5 A</i>
<i>Ambient temperature</i>	<i>28°C Max</i>
<i>Generated heat</i>	<i>2300 Watts in ambient heat</i>
<i>Weight Kg</i>	<i>120</i>
<i>Water supply and drain</i>	<i>Not needed</i>
<i>Coolant</i>	<i>R134A</i>
<i>Production</i>	<i>Made in Italy</i>

- 1** Parete di ghiaccio Polaris  
*Polaris ice wall*
- 2** Generatore  
*Generator*
- 3** Vano tecnico ispezionabile  
*Plant room*
- 4** Interno cabina  
*Ice room*





le soluzioni per il relax  
*ideas for relaxation*

# Alba



## Alba

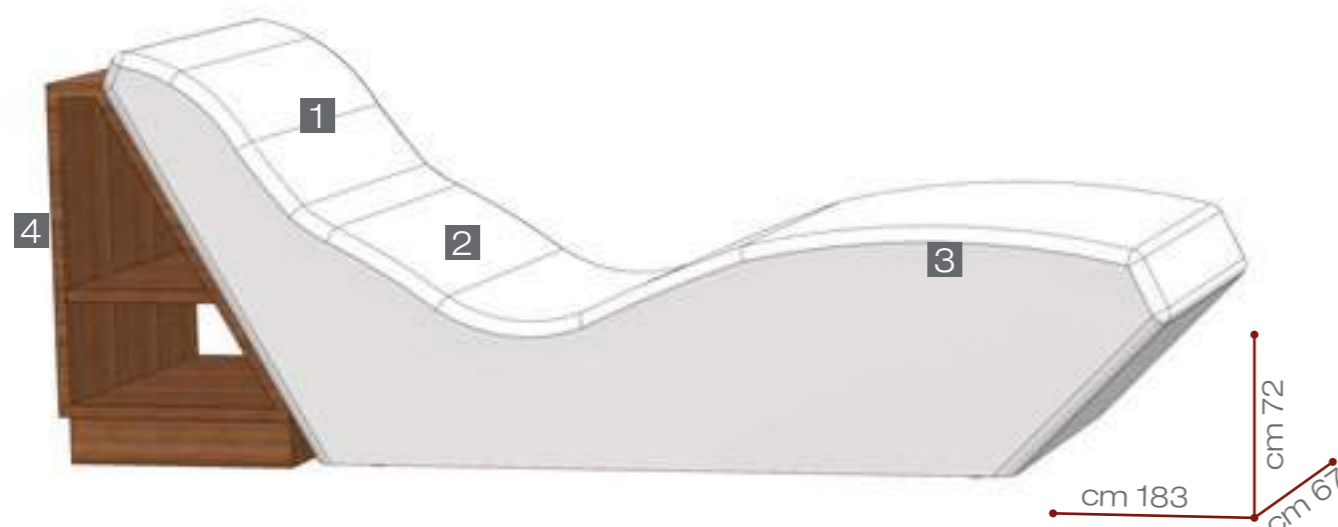

- 1** Posizione ergonomica  
*Ergonomic shape*
- 2** Supporto lombare  
*Lumbar support*
- 3** Ginocchia all'altezza del cuore per stimolare la circolazione dopo sauna  
*Knees at heart level to stimulate blood flow after sauna*
- 4** Portariviste opzionale  
*Optional shelf*

## Scheda tecnica

Dimensioni	cm 183x67x72h
Materiale struttura	Telaio in legno multistrato
Materiale imbottitura	Poliuretano indeformabile
Materiale rivestimento	Ecopelle ignifuga certificata
Peso Kg	30
Posizione	Fissa
Resistenza al fuoco	Omologazione in classe 1 IM
Adatto per ambienti umidi	Si
Adatto per esterni	No
Adatto per stanze del sale	Si
Imballo	cm 190x70x75h
Produzione	Made in Italy

## Materiali

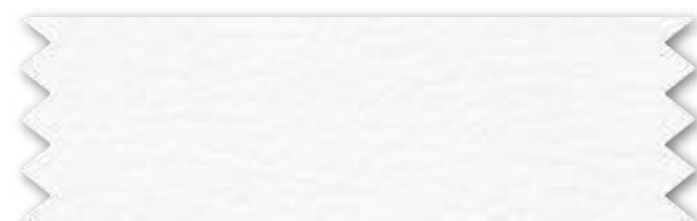

Bianco

White



Grigio

Grey



Beige

Beige



Marrone

Brown

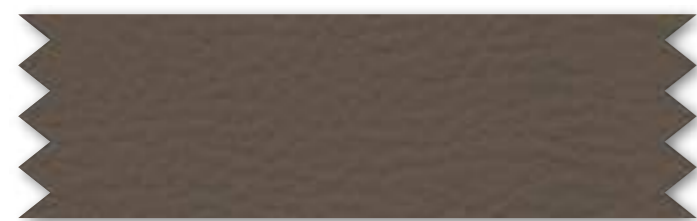

Tortora

Dove-grey



Rosso

Red

## Materials

## Datasheet

<i>Dimensions</i>	<i>cm 183x67x72h</i>
<i>Frame material</i>	<i>Plywood</i>
<i>Padding material</i>	<i>Non-deformable polyurethane foam</i>
<i>Upholstery material</i>	<i>Certified fire resistant leatherette</i>
<i>Weight (Kg)</i>	<i>30</i>
<i>Position</i>	<i>Fixed</i>
<i>Fireproof</i>	<i>1 IM Class certification</i>
<i>Suitable for humid environments</i>	<i>Yes</i>
<i>Suitable for outdoor use</i>	<i>No</i>
<i>Suitable for salt rooms</i>	<i>Yes</i>
<i>Packaging</i>	<i>cm 190x70x75h</i>
<i>Production</i>	<i>Made in Italy</i>

Le immagini sono puramente indicative. Campioni disponibili su richiesta. Images shown are for illustration purposes only. Samples are available.

# Alba Plus

Lettini riscaldati  
*Heated loungers*





## Alba Plus

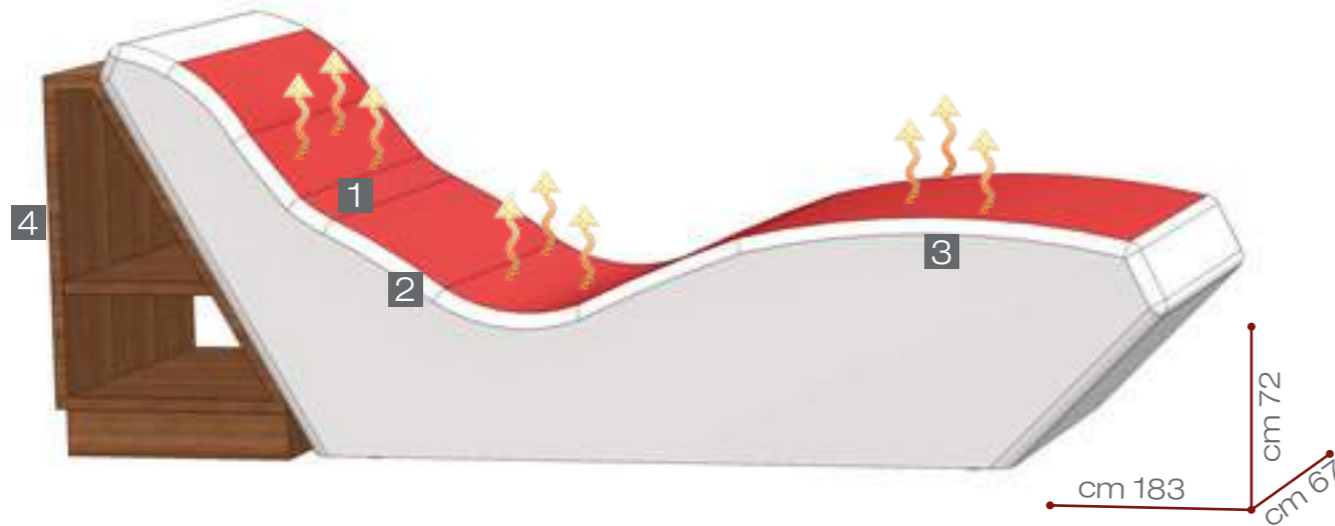

- 1** Superficie riscaldata  
*Heated surface*
- 2** Supporto lombare  
*Lumbar support*
- 3** Ginocchia all'altezza del cuore per stimolare la circolazione dopo sauna  
*Knees at heart level to stimulate blood flow after sauna*
- 4** Portariviste opzionale  
*Optional shelf*

## Scheda tecnica

Dimensioni	cm 183x67x72h
Allacciamento elettrico	400 W, 230 V AC, 1,74 A
Resistenza scaldante	Al carbonio, in bassa tensione 24V
Materiale struttura	EPS ad alta densità
Materiale rivestimento	Mosaico di vetro
Peso Kg	75
Posizione	Reclinata ergonomica
Adatto per ambienti umidi	Si
Adatto per esterni	No
Adatto per stanze del sale	Si
Imballo	cm 190x70x100h
Produzione	Made in Italy

## Materiali

## Materials



Bianco

White



Grigio

Grey



Beige

Beige



Marrone

Brown



Tortora

Dove-grey



Rosso

Red

Le immagini sono puramente indicative. Campioni disponibili su richiesta. Images shown are for illustration purposes only. Samples are available.

## Datasheet

<i>Dimensions</i>	<i>cm 183x67x72h</i>
<i>Power supply</i>	<i>400 W, 230 V AC, 1,74 A</i>
<i>Heating element</i>	<i>Carbon fibre, 24V</i>
<i>Structure material</i>	<i>High-density EPS</i>
<i>Surface material</i>	<i>Glass mosaic</i>
<i>Weight (Kg)</i>	<i>75</i>
<i>Position</i>	<i>Reclined ergonomic</i>
<i>Suitable for humid environments</i>	<i>Yes</i>
<i>Suitable for outdoor use</i>	<i>No</i>
<i>Suitable for salt rooms</i>	<i>Yes</i>
<i>Packaging</i>	<i>cm 190x70x100h</i>
<i>Production</i>	<i>Made in Italy</i>

# Flex 4

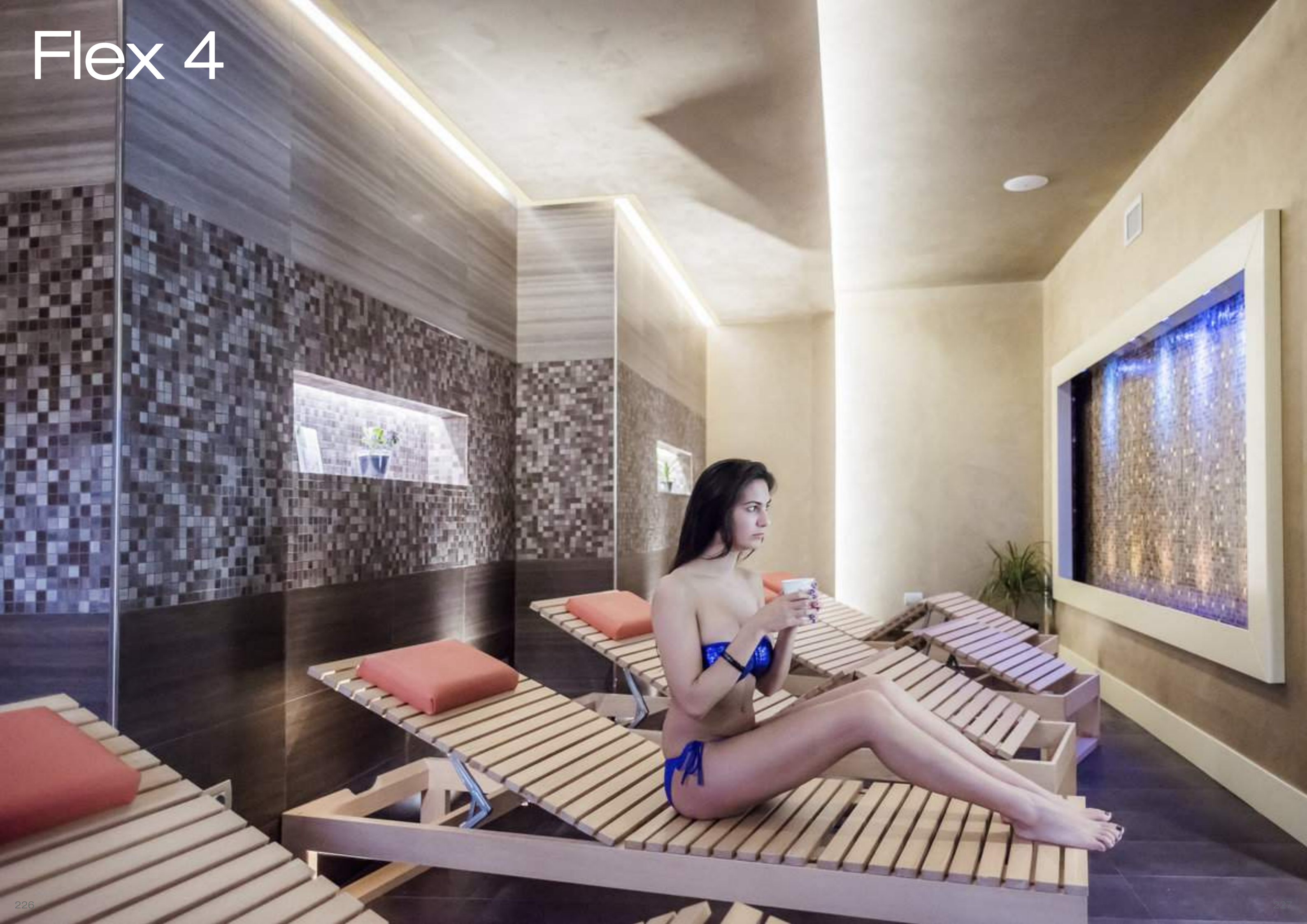

## Flex 4

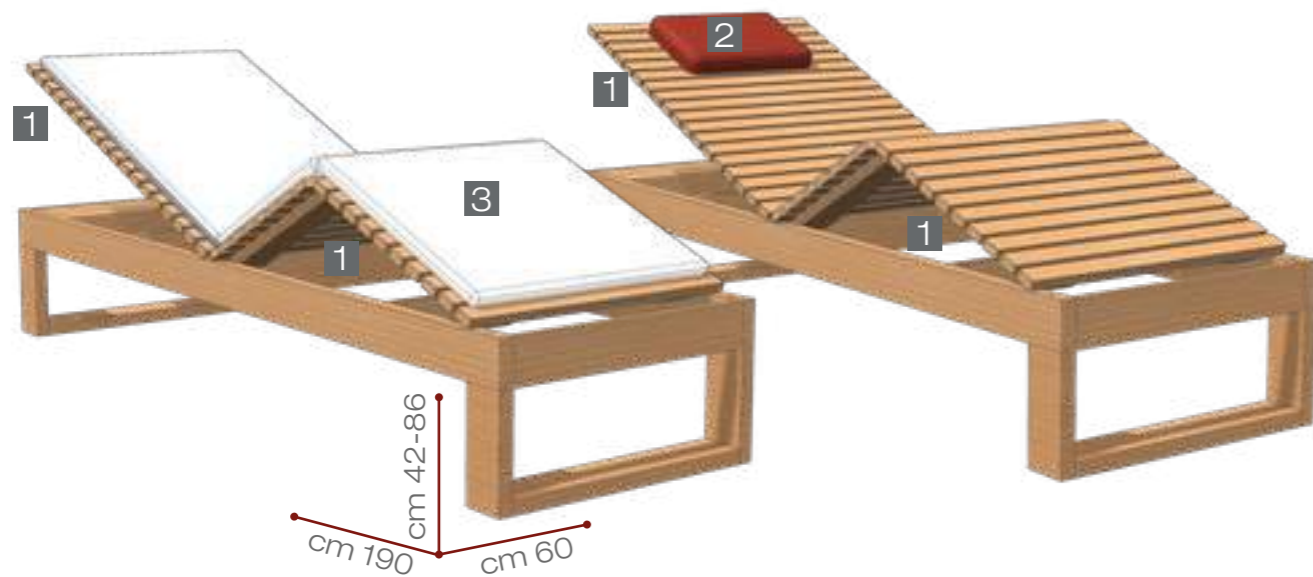

- 1** Gambe e schiena regolabili in 4 posizioni  
*Back and legs adjustable in 4 positions*
- 2** Cuscino incluso di serie  
*Pillow included*
- 3** Materassino opzionale  
*Optional mattress*



### Finiture materassino

### Mattress finishes



Bianco

White



Grigio

Grey

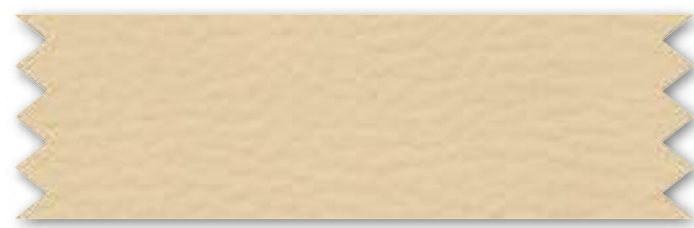

Beige

Beige



Marrone

Brown



Tortora

Dove-grey



Rosso

Red

Le immagini sono puramente indicative. Campioni disponibili su richiesta. Images shown are for illustration purposes only. Samples are available.

## Scheda tecnica

Dimensioni	Cm 190x60x42 - 86h
Materiale struttura	Pregiato legno di Faggio di prima scelta, verniciato all'acqua
Materiale cuscino	Ecopelle
Materassino	Optional materassino morbido in ecopelle
Peso Kg	40
Regolazione schienale	4 posizioni
Regolazione gambe	4 posizioni
Adatto per ambienti umidi	Si
Adatto per esterni	Sì, se protetto dalle intemperie
Imballo	Cm 200x70x20h
Produzione	Made in Italy

### Datasheet

<i>Dimensions</i>	<i>cm 190x60x42 - 86h</i>
<i>Frame material</i>	<i>First-choice Beech wood, coated with transparent paint</i>
<i>Cushion material</i>	<i>Leatherette</i>
<i>Mat</i>	<i>Optional soft mattress in leatherette</i>
<i>Weight (Kg)</i>	<i>40</i>
<i>Adjustable backrest</i>	<i>4 positions</i>
<i>Adjustable legrest</i>	<i>4 positions</i>
<i>Suitable for humid environments</i>	<i>Yes</i>
<i>Suitable for outdoor use</i>	<i>Yes, protected from direct rain</i>
<i>Packaging</i>	<i>cm 200x70x20h</i>
<i>Production</i>	<i>Made in Italy</i>

# Tepidarium





Tepidarium



## Scheda tecnica

<b>Funzione</b>	Una soluzione innovativa per aree relax, una stanza riscaldata dove i sensi vengono coccolati per regalare un'esperienza unica. Ogni 5 minuti il colore della luce cambia, creando un senso di anticipazione, e un sistema automatico immette dell'acqua aromatizzata sopra le pietre calde, immergendo l'ambiente in un'atmosfera molto particolare.
<b>Potenza elettrica</b>	4,5 kW, 400 VAC 3-fase, 6,5 A / 4,5 kW 230 VAC 1-fase, 19,5 A
<b>Potenze maggiori</b>	Su richiesta
<b>Alimentazione idraulica</b>	Acqua fredda, 2-4 bar, 4 litri/min, attacchi da 1/2" GAS UNI ISO 228/1
<b>Dimensioni</b>	cm 68 x 68 x 135h
<b>Materiale</b>	Legno di Frassino termotrattato

## Datasheet

<b>Function</b>	<i>An innovative solution for relaxation areas, a heated room where the senses are embraced by a unique experience. Every 5 minutes the light colour changes, creating a sense of anticipation, and a fine aromatic mist is sprayed on top of the warm stones, creating a highly suggestive atmosphere.</i>
<b>Electric power</b>	4,5 kW, 400 VAC 3-phase, 6,5 A / 4,5 kW 230 VAC 1-phase, 19,5 A
<b>Additional power</b>	On request
<b>Water supply</b>	Cold water, 2-4 bar, 4 litres/minute, connections 1/2" GAS UNI ISO 228/1
<b>Dimensions</b>	cm 68 x 68 x 135h
<b>Material</b>	Thermo-treated Ash wood

- 1 Tepidarium  
Tepidarium
- 2 Dosatore aromi  
Aroma doser
- 3 Alimentazione elettrica  
Power supply
- 4 Allacciamento acqua  
Water supply
- 5 Collegamento elettrico/idraulico  
Electric / Hydraulic connections

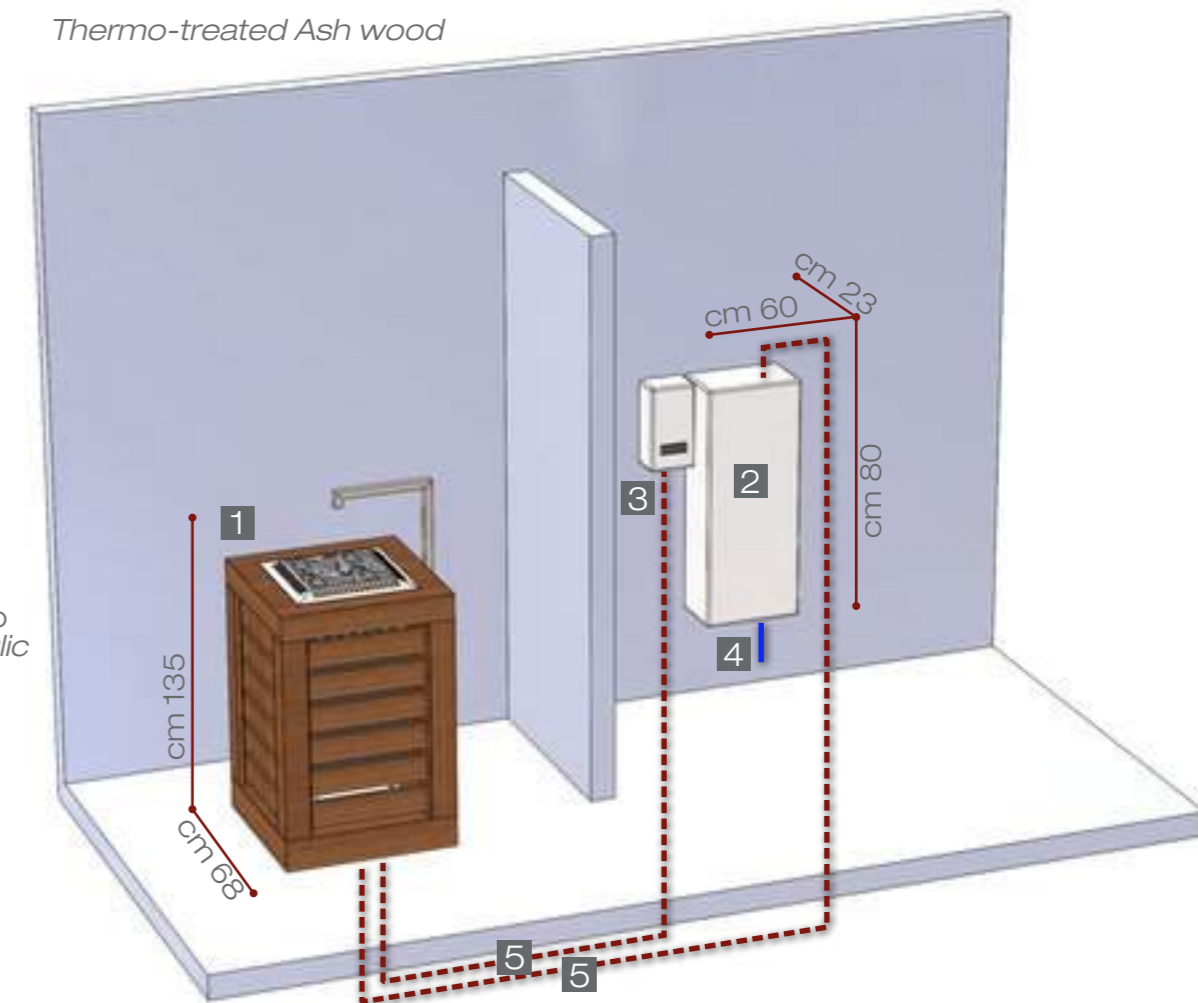

# Parete di sale

*Salt wall*



Parete di sale

*Salt wall*

scala 1:1,5

*scale 1:1,5*

## Scheda tecnica

Funzione	Decorativa
Colore del sale	Rosa
Provenienza del sale	Hymalaya
Spessore	17 cm
Peso	120 Kg/m <sup>2</sup>
Sistema di illuminazione	LED, sostituibile
Colore retroilluminazione	Bianco caldo, 2700°K
Alimentazione	22 W (1 A) / m <sup>2</sup> , 110-240 VAC
Normative	CE + UL/ETL

## *Datasheet*

<i>Function</i>	<i>Decoration</i>
<i>Salt colour</i>	<i>Pink</i>
<i>Salt origin</i>	<i>Hymalaya</i>
<i>Wall thickness</i>	<i>17 cm</i>
<i>Weight</i>	<i>120 Kg/m<sup>2</sup></i>
<i>Lighting system</i>	<i>LED, replaceable</i>
<i>Light colour</i>	<i>Warm white, 2700°K</i>
<i>Power supply</i>	<i>22 W (1 A) / m<sup>2</sup>, 110-240 VAC</i>
<i>Norms</i>	<i>CE + UL/ETL</i>

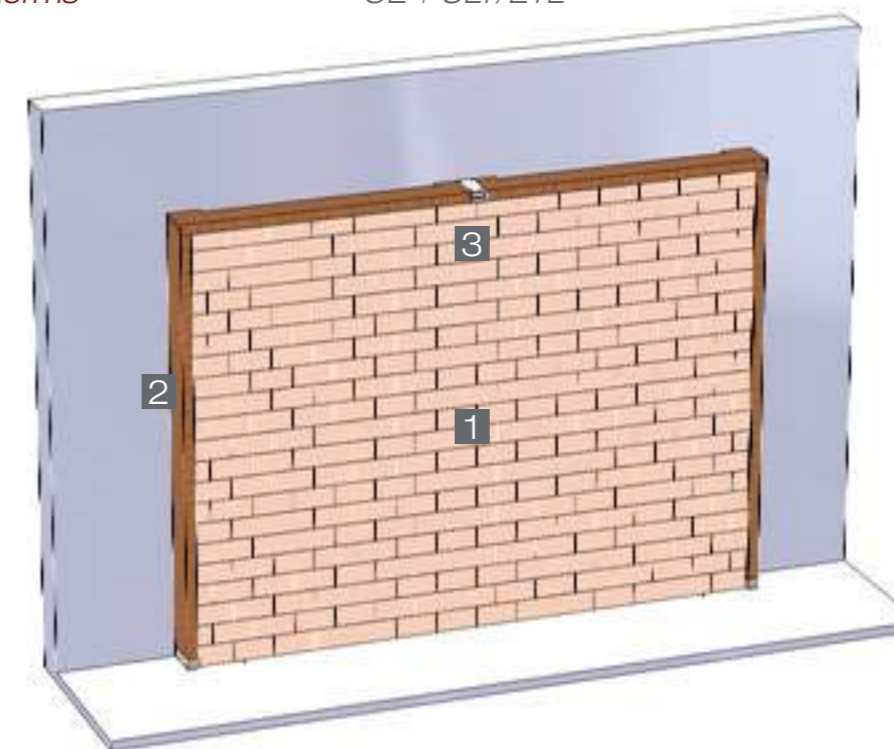

- 1 Parete di sale  
*Salt wall*
- 2 Cornice opzionale in legno  
*Optional timber frame*
- 3 Alimentazione elettrica  
*Power supply*



# Tepidarium al sale

## *Salt tepidarium*





## Scheda tecnica

Funzione	La stufa riscalda i cristalli di sale, sprigionandone dolcemente il profumo nella zona relax e riscaldando l'ambiente ad una temperatura piacevole.
Potenza elettrica	4,5 kW, 400 VAC 3-fase, 6,5 A / 4,5 kW 230 VAC 1-fase, 19,5 A
Potenze maggiori	Su richiesta
Dimensioni	cm 68 x 68 x 135h
Materiale	Sale rosa dell'Himalaya e legno di Frassino termotrattato

## Datasheet

Function	The heater warms up the salt crystals, spreading their scent and heating the room at a pleasant temperature.
Electric power	4,5 kW, 400 VAC 3-phase, 6,5 A / 4,5 kW 230 VAC 1-phase, 19,5 A
Additional power	On request
Dimensions	cm 68 x 68 x 135h
Material	Himalaya pink salt and thermo-treated Ash wood

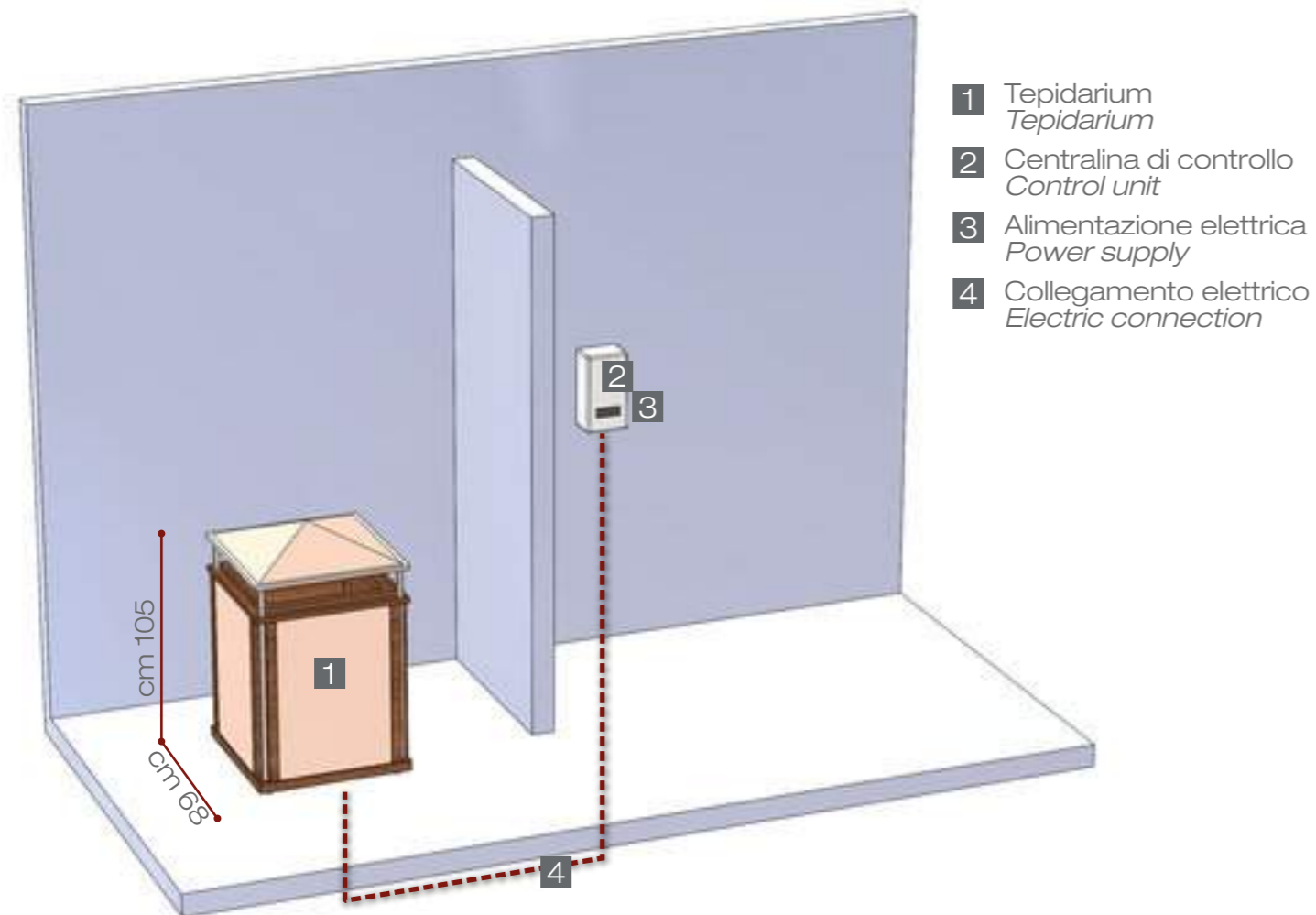

## Cornice per pareti di sale



Frassino termotrattato  
Thermo-treated ash

## Salt walls timber frame



Ayous  
Abachi

# myHeat

Seduta infrarossi

Infrared seat



## Scheda tecnica

Funzione	Seduta con riscaldamento ad infrarossi
Zona di riscaldamento	Schiena
Infrarossi	Emettitore Philips Vitae con irradiazione ad ampio spettro IR A + B + C
Potenza elettrica	350W
Alimentazione	230 VAC 1,6 A
Materiale	Legno
Imbottitura	Ecopelle certificato
Normative	CE

## Datasheet

Function	Seat with infrared heating
Heat zone	Back
Infrared	Philips Vitae emitter with wide band radiation IR A + B + C
Power	350W
Power supply	230 VAC 1,6 A
Material	Wood
Padding	Certified leatherette
Norms	CE

- 1 Seduta  
Seat
- 2 Emittitore infrarossi  
Infrared emitter
- 3 Cuscini imbottiti  
Padded cushions
- 4 Dimmer  
Dimmer
- 5 Presa Shuko  
Shuko plug

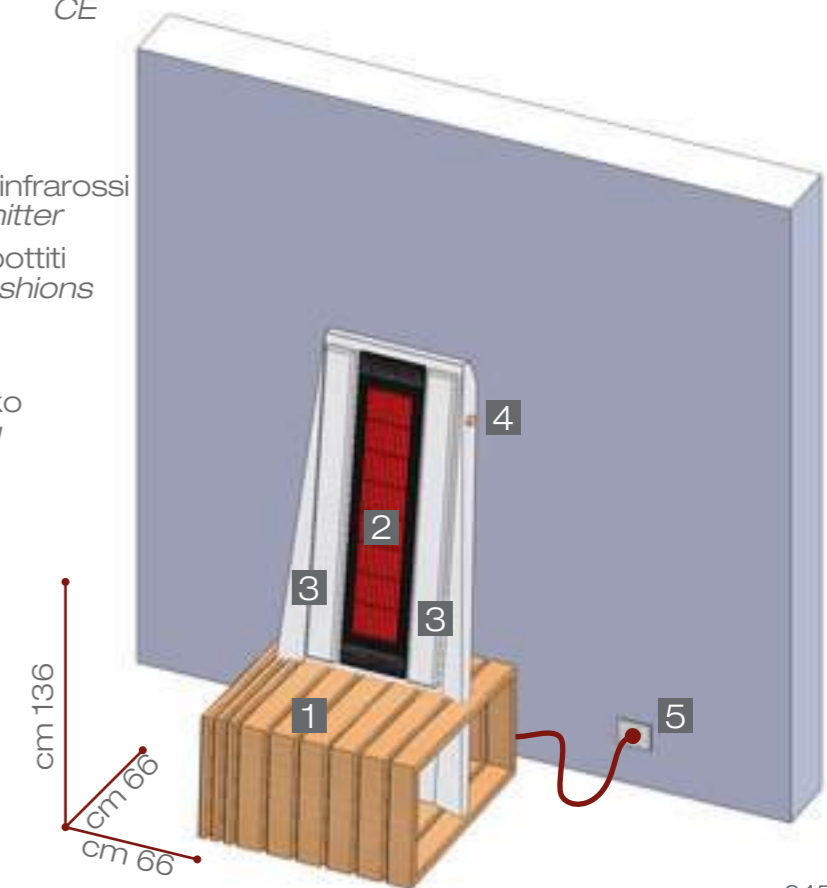

# Stone Q

Tavolo hammam

*Hammam table*



Villaverde Golf & Resort, Fagagna, ITALY

**Stone Q** è il lettino ideale per trattamenti umidi, quali olii, fanghi o alghe, composto da un piano riscaldato in quarzite ricavato da un'unica lastra, che consente una piacevole ed uniforme distribuzione del calore. L'assenza di fughe evita il ristagno dei fanghi, facilitandone la pulizia; una canalina perimetrale raccoglie acqua e prodotti residui, facendoli defluire in un decantatore interno che ne consente il corretto smaltimento. Un doccino regolabile completa questo "lettino di pietra", dal design unico e di facile installazione. Su richiesta può essere dotato di dosatore di schiuma di sapone, per trattamenti quali savonage e hammam.

**Stone Q** is the ideal wet treatments table, made by a heated quartzite slab, which allows a pleasant and uniform distribution of heat. No junctions means no place where oils, algae or mud can get stuck, therefore cleaning is very easy. A perimeter drain channel collects water and residue products and drives them to an internal tank for correct disposal. An adjustable handshower completes this stone table, unique in its design and easy to install. Can be fitted on request with a foam dosing system for savonage and hammam treatments.



## Scheda tecnica

Dimensioni	Cm 220x81,5x79h
Materiale	Quarzite con particelle di argento attivo con funzione antibatterica
Colore	Colore coffee; altri colori su richiesta.
Pianale	Realizzato in pezzo unico, senza giunture, per una massima igiene.
Riscaldamento	Elettrico, con temperatura regolabile
Peso Kg	450
Pilette di scarico	Incluse 2 pilette con vasca di decantazione fanghi ispezionabile
Doccino flessibile	Incluso
Trattamenti possibili	Savonage, Rasul, Hammam, e tutti i tipi di trattamenti con fanghi, alghe, vino, cioccolato, miele, prodotti estetici.
Optional	Dosatore di schiuma di sapone
Alimentazione idraulica	calda + fredda, 2-4 bar, 16 litri/min, attacchi da 1/2" GAS UNI ISO 228/1
Alimentazione elettrica	1800 W, 230 VAC, 7,9 A
Produzione	Made in Italy

## Datasheet

<i>Dimensions</i>	<i>Cm 220x81,5x79h</i>
<i>Material</i>	<i>Quarzite with active silver particles with antibacterial function</i>
<i>Colour</i>	<i>Coffee. Other colours on demand.</i>
<i>Surface</i>	<i>Carved from a single slab, for maximum hygiene.</i>
<i>Heating</i>	<i>Electric, with adjustable temperature</i>
<i>Weight kg</i>	<i>450</i>
<i>Drain</i>	<i>2 drains included, with removable mud settling tank</i>
<i>Flexible hand shower</i>	<i>Included</i>
<i>Possible treatments</i>	<i>Savonage, Rasul, Hammam, and all kind of treatments with mud, algae, wine, chocolate, honey, cosmetic products.</i>
<i>Optional</i>	<i>Soap foam doser</i>
<i>Water supply</i>	<i>warm + cold, 2-4 bar, 16 litres/min, connections 1/2" GAS UNI ISO 228/1</i>
<i>Alimentazione elettrica</i>	<i>1800 W, 230 VAC, 7,9 A</i>
<i>Production</i>	<i>Made in Italy</i>

- 1 Piano riscaldato  
*Heated surface*
- 2 Vasca di decantazione fanghi  
*Mud collection tank*
- 3 Doccino flessibile  
*Flexible handshower*
- 4 Controllo  
*Control*
- 5 Allacciamento acqua + elettrico  
*Water + power supply*

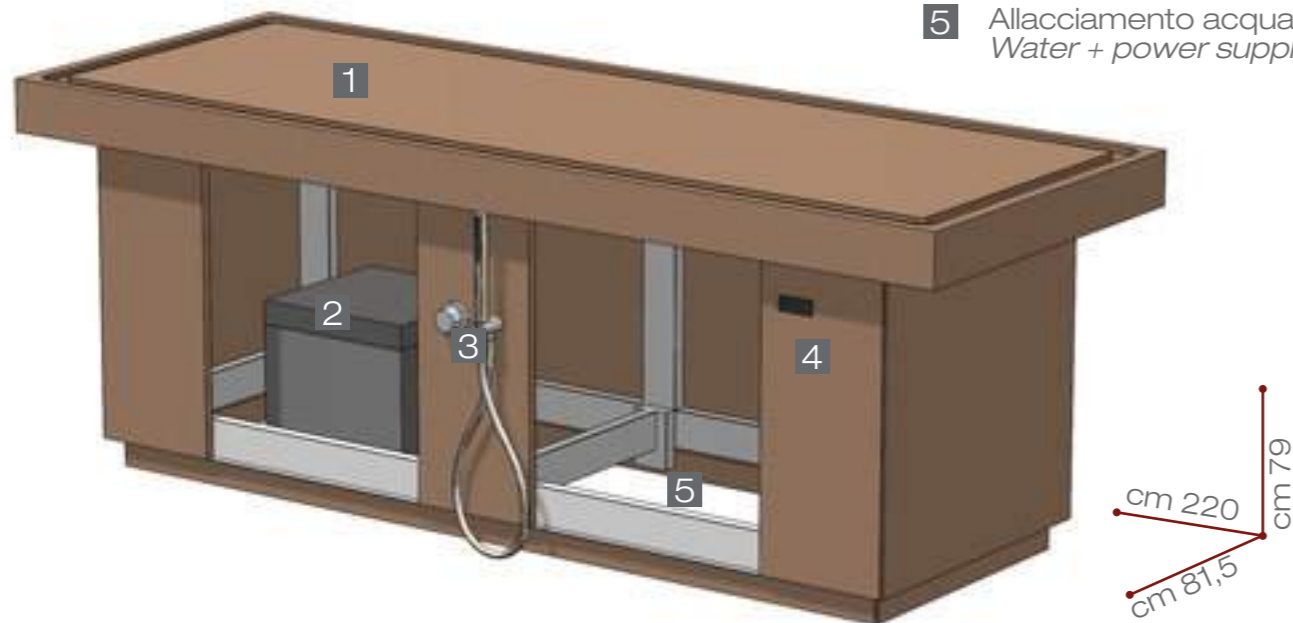

# Foot spa





## Scheda tecnica

Funzioni	Idromassaggio plantare
Temperatura	Regolabile dall'utente
Durata	A discrezione dell'utente
Attivazione massaggio	A pulsante
Materiale	Corian™ - per garantire la massima igiene
Assorbimento elettrico	500 W, 230V AC, 1,3 A
Allacciamento acqua	Calda+fredda, 2-4 bar, max 15 litri/minuto, attacchi da 1/2" GAS
Distanza dal vano tecnico	Max 7 metri lunghezza tubi
Normative	CE
Produzione	Made in Italy

## Datasheet

<i>Function</i>	<i>Feet hydro massage</i>
<i>Temperature</i>	<i>Adjustable by the user</i>
<i>Duration</i>	<i>At the discretion of the user</i>
<i>Activation</i>	<i>By button</i>
<i>Material</i>	<i>Corian™ - for enhanced hygiene and to avoid accidental chipping</i>
<i>Power supply</i>	<i>500 W, 230V AC, 1,3 A</i>
<i>Water supply</i>	<i>Hot+cold, 2-4 bar, max 15 litres/minute, connections 1/2" GAS</i>
<i>Distance from plant room</i>	<i>Maximum 7 metres pipe length</i>
<i>Norms</i>	<i>CE</i>
<i>Production</i>	<i>Made in Italy</i>

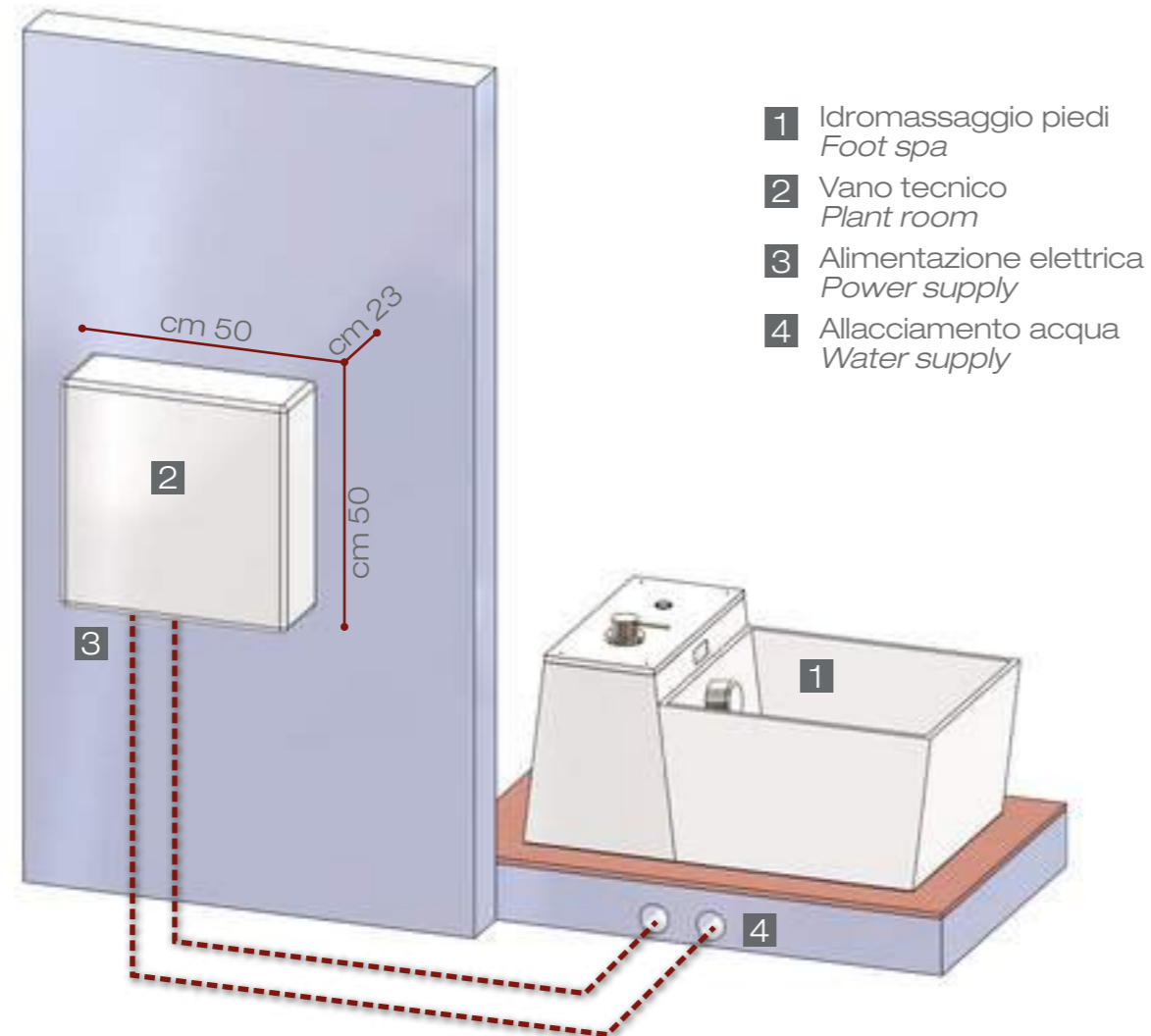

# Disinfezione piedi

## Feet disinfection

### Scheda tecnica

Funzioni	Disinfezione piedi tramite dosaggio di soluzione antimicotica
Sistema	Con acqua a perdere
Postazioni	Postazione fissa + postazione mobile per disinfezione superfici
Pompa	Inclusa, regolabile
Allacciamento elettrico	Non richiesto
Allacciamento acqua	Calda+fredda, 2 - 4 bar, 15 litri/minuto, attacchi da 1/2" GAS
Distanza dal vano tecnico	Max 7 metri lunghezza tubi
Normative	CE
Produzione	Made in Italy

### Datasheet

<i>Function</i>	<i>Feet disinfection through anti-micotic solution dosage</i>
<i>System</i>	<i>Disposable water</i>
<i>Outlets</i>	<i>Fixed outlet + mobile outlet for surfaces disinfection</i>
<i>Pump</i>	<i>Included, adjustable</i>
<i>Power supply</i>	<i>Not required</i>
<i>Water supply</i>	<i>Hot+cold, 2-4 bar, 15 litres/minute, connections 1/2" GAS</i>
<i>Distance from plant room</i>	<i>Maximum 7 metres pipe length</i>
<i>Norms</i>	<i>CE</i>
<i>Production</i>	<i>Made in Italy</i>

- 1 Postazione fissa  
Fixed nozzle
- 2 Postazione mobile  
Mobile nozzle
- 3 Impianto di dosaggio  
Dosing station
- 4 Allacciamento acqua  
Water supply
- 5 Tubo flessibile 15m  
Flexible hose 15m
- 6 Tanica 10l antimicotico  
Antimicotic tank 10l
- 7 Scarico  
Drain

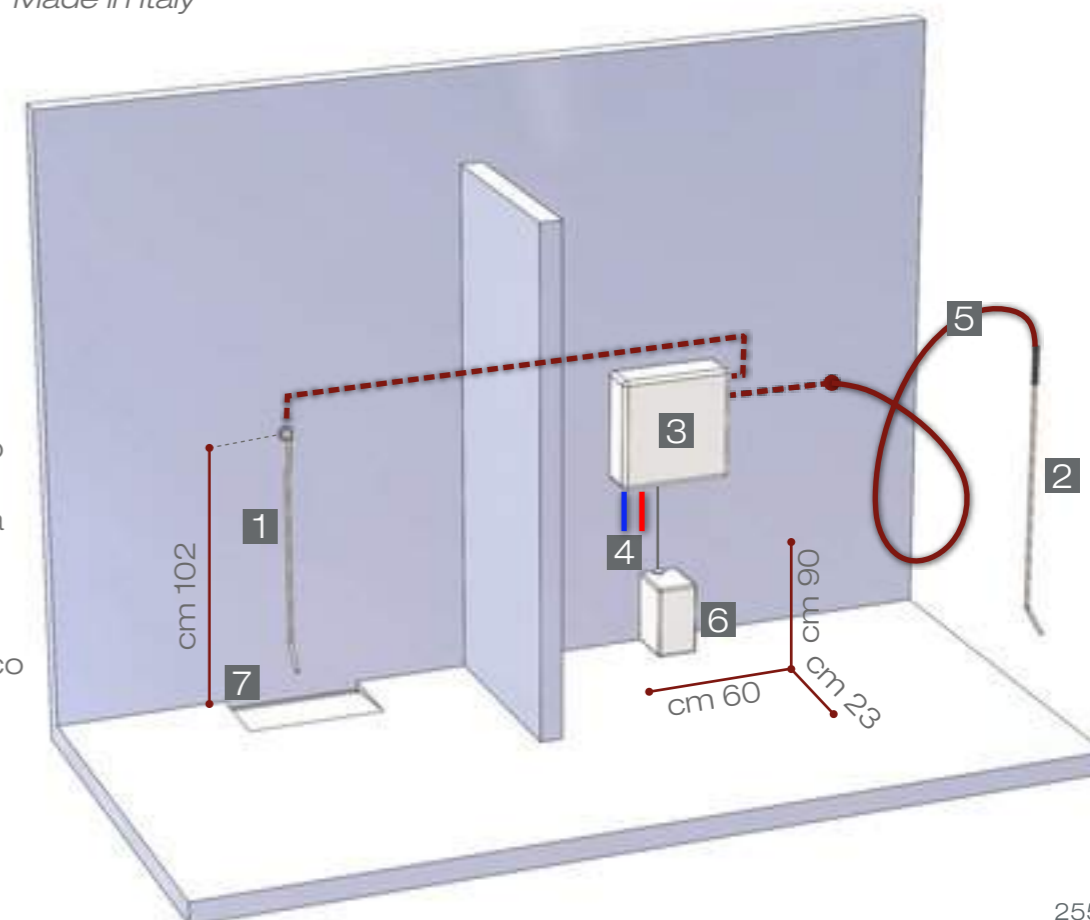





le ispirazioni per il benessere  
*spa design inspirations*

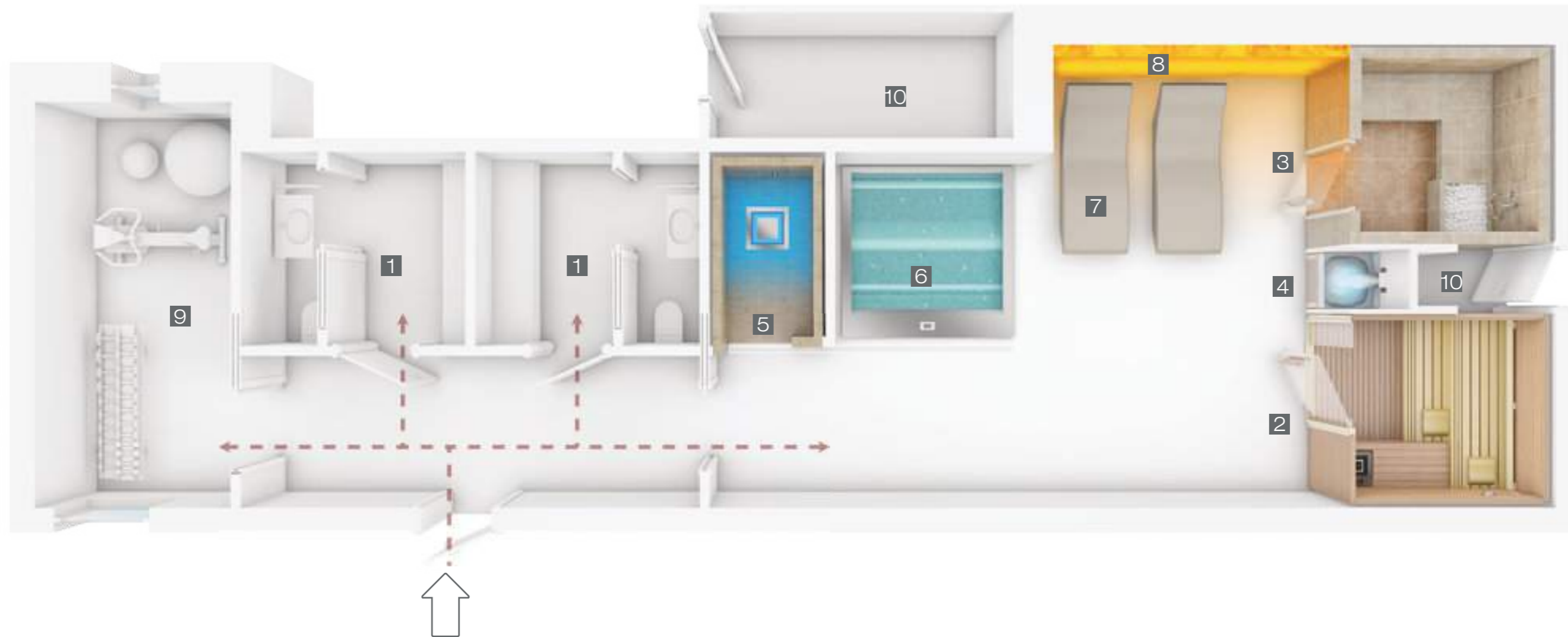

- 1** Spogliatoi e WC  
*Changing room and toilet*
- 2** Sauna  
*Sauna*
- 3** Bagno turco  
*Steam bath*
- 4** Cascata di ghiaccio  
*Ice fountain*
- 5** Doccia emozionale RAY  
*Experience shower RAY*

- 6** Idromassaggio  
*Jacuzzi*
- 7** Chaise longue Alba  
*Alba chaise longue*
- 8** Parete di sale  
*Salt wall*
- 9** Palestra  
*Gym*
- 10** Vano tecnico  
*Plant room*



- 1** Reception  
*Reception*
- 2** Spogliatoi e WC  
*Changing room and toilet*
- 3** Sauna  
*Sauna*
- 4** Bagno turco  
*Steam bath*
- 5** Cascata di ghiaccio  
*Ice fountain*

- 6** Doccia emozionale Ray  
*Experience shower Ray*
- 7** Polaris  
*Polaris*
- 8** Chaise longue Alba  
*Alba chaise longue*
- 9** Parete di sale  
*Salt wall*
- 10** Tisaneria  
*Tea and drinks*

- 11** Vano tecnico  
*Plant room*
- 12** Lettino massaggi  
*Massage table*
- 13** Carrellino Service  
*Service trolley*
- 14** Palestra  
*Gym*



- |   |   |   |   |
|---|---|---|---|
| <b>1</b> Sauna<br><i>Sauna</i>                                  | <b>6</b> Percorso Kneipp<br><i>Kneipp path</i>            | <b>11</b> Parete di sale<br><i>Salt wall</i>                    | <b>16</b> Lettino massaggi<br><i>Massage table</i>  |
| <b>2</b> Bagno turco<br><i>Steam bath</i>                       | <b>7</b> Doccia rustica<br><i>Bucket shower</i>           | <b>12</b> Tisaneria<br><i>Tea and drinks</i>                    | <b>17</b> Carrellino Service<br><i>Service Cart</i> |
| <b>3</b> Percorso docce Paradise<br><i>Paradise shower path</i> | <b>8</b> Foot Spa<br><i>Foot Spa</i>                      | <b>13</b> Float Room<br><i>Float Room</i>                       | <b>18</b> Palestra<br><i>Gym</i>                    |
| <b>4</b> Cascata di ghiaccio<br><i>Ice fountain</i>             | <b>9</b> Panca riscaldata<br><i>Heated bench</i>          | <b>14</b> Lettino hammam Stone Q<br><i>Hammam table Stone Q</i> | <b>19</b> Vano tecnico<br><i>Plant Room</i>         |
| <b>5</b> Doccia emozionale Ray<br><i>Experience shower Ray</i>  | <b>10</b> Chaise longue Alba<br><i>Alba chaise longue</i> | <b>15</b> Steam shower<br><i>Steam shower</i>                   |   |

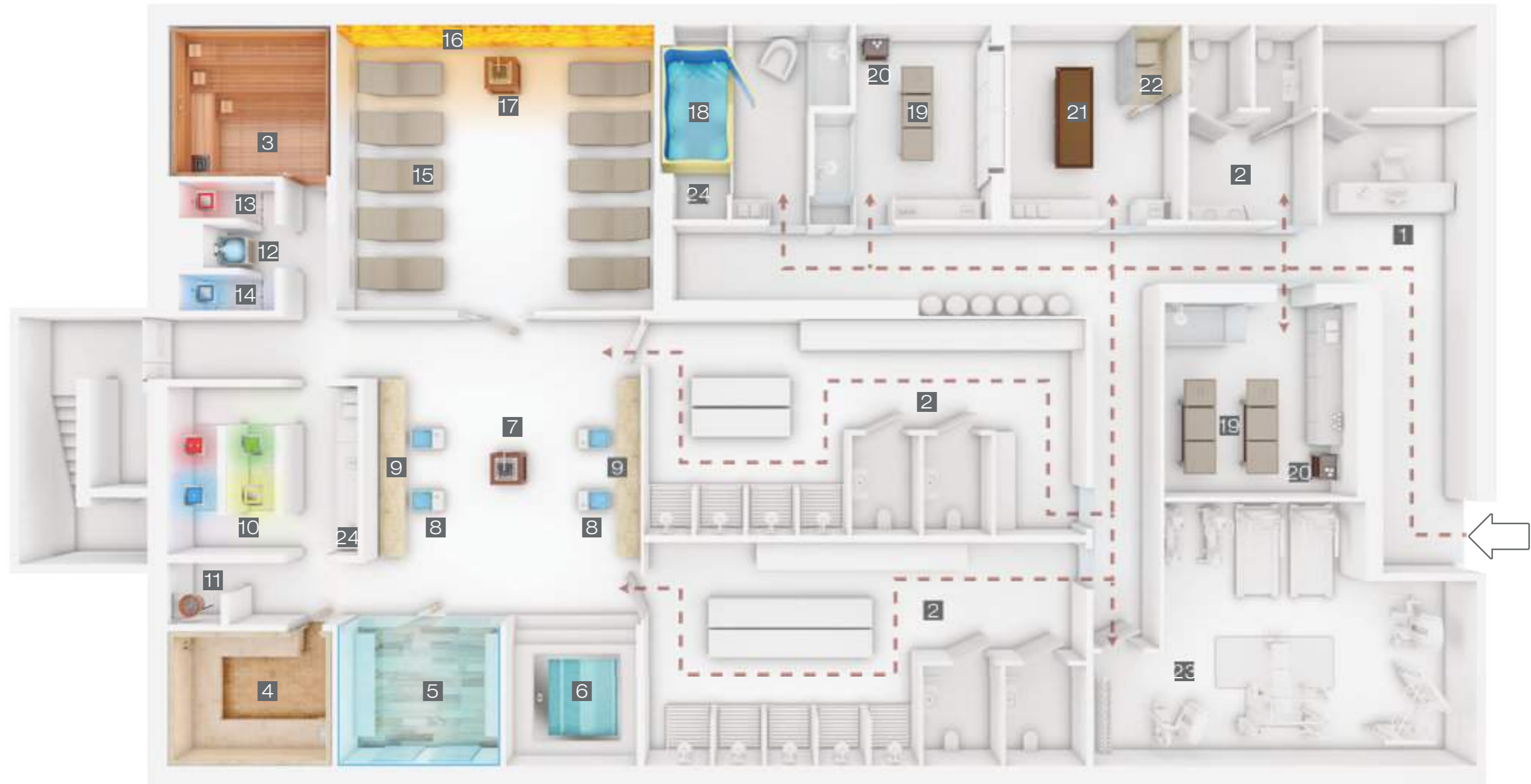

- |   |  |   |   |
|---|--|---|---|
| <b>1</b> Reception<br><i>Reception</i>                      | <b>7</b> Tepidarium<br><i>Tepidarium</i>                         | <b>13</b> Doccia emozionale Mekong<br><i>Experience shower Mekong</i> | <b>19</b> Lettino massaggi<br><i>Massage table</i>              |
| <b>2</b> Spogliatoi e WC<br><i>Changing room and toilet</i> | <b>8</b> Foot Spa<br><i>Foot spa</i>                             | <b>14</b> Doccia emozionale Volga<br><i>Experience shower Volga</i>   | <b>20</b> Carrellino Service<br><i>Service cart</i>             |
| <b>3</b> Sauna<br><i>Sauna</i>                              | <b>9</b> Panca riscaldata<br><i>Heated bench</i>                 | <b>15</b> Chaise longue Alba<br><i>Alba chaise longue</i>             | <b>21</b> Lettino hammam Stone Q<br><i>Stone Q hammam table</i> |
| <b>4</b> Bagno turco<br><i>Steam bath</i>                   | <b>10</b> Percorso docce Paradise<br><i>Paradise shower path</i> | <b>16</b> Parete di sale<br><i>Salt wall</i>                          | <b>22</b> Steam shower<br><i>Steam shower</i>                   |
| <b>5</b> Cabina Polaris<br><i>Polaris ice room</i>          | <b>11</b> Doccia rustica<br><i>Bucket shower</i>                 | <b>17</b> Tepidarium al sale<br><i>Salt tepidarium</i>                | <b>23</b> Palestra<br><i>Gym</i>                                |
| <b>6</b> Vasca idromassaggio<br><i>Hydromassage</i>         | <b>12</b> Cascata di ghiaccio<br><i>Ice fountain</i>             | <b>18</b> Floating room<br><i>Floating room</i>                       | <b>24</b> Vano tecnico<br><i>Plant room</i>                     |



Nessuna parte di questo catalogo può essere riprodotta in qualunque forma senza autorizzazione di Stenal srl.

*This catalogue cannot be reproduced in any way without prior authorisation from Stenal srl.*

I prodotti rappresentati in questo catalogo si riferiscono al momento della pubblicazione. Stenal si riserva il diritto di variare qualsiasi aspetto dei prodotti, inclusi misure, materiali e design, e di eliminare qualsiasi articolo ogni qualvolta lo ritenga necessario, anche senza preavviso.

*This catalogue shows the items available at the time it was published. Stenal reserves the right to change all aspects of the products, including their dimensions, materials and design and to remove any item, if it deems it necessary, without prior notice.*

Dal 1980 lavoriamo con passione  
per creare prodotti eccezionali.

*Since 1980 we have been working with passion  
to create amazing products.*

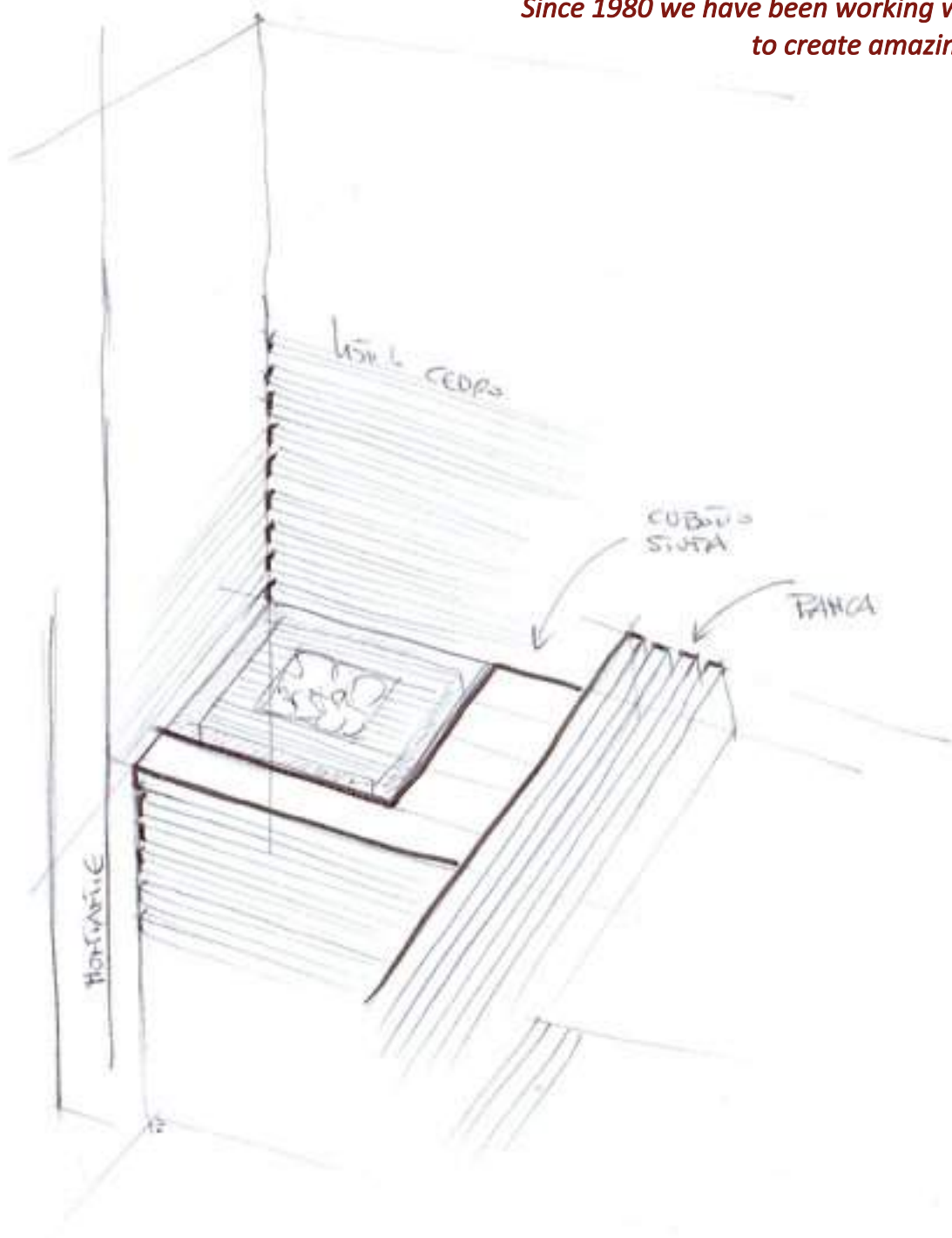

Via A. Barovier 8 - 35031 Abano Terme (PD) - Italy  
Tel. +39 049 8912047 Fax +39 049 8926752  
www.stenal.it commerciale@stenal.it